

Panasonic

DVD/VIDEO CD/CD Player

DVD-A350A

Operating Instructions



Before attempting to connect, operate or adjust this product, please read the instructions completely. Please save this manual.

VQT7410

Safety information

Note:

This unit can be used only where the power supply is AC 220-240 V, 50 Hz. It cannot be used elsewhere.

CAUTION:

DVD/VIDEO CD/CD PLAYER IS A CLASS 1 LASER PRODUCT. HOWEVER THIS DVD/VIDEO CD/CD PLAYER USES A VISIBLE LASER BEAM WHICH COULD CAUSE HAZARDOUS RADIATION EXPOSURE IF DIRECTED. BE SURE TO OPERATE THE DVD/VIDEO CD/CD PLAYER CORRECTLY AS INSTRUCTED.

WHEN THIS DVD/VIDEO CD/CD PLAYER IS PLUGGED TO THE WALL OUTLET, DO NOT PLACE YOUR EYES CLOSE TO THE OPENING OF THE DISC TRAY AND OTHER OPENINGS TO LOOK INTO THE INSIDE OF THIS PLAYER.

USE OF CONTROLS OR ADJUSTMENTS OR PERFORMANCE OF PROCEDURES OTHER THAN THOSE SPECIFIED HEREIN MAY RESULT IN HAZARDOUS RADIATION EXPOSURE.

DO NOT OPEN COVERS AND DO NOT REPAIR YOURSELF. REFER SERVICING TO QUALIFIED PERSONNEL.

WARNING:

TO REDUCE THE RISK OF FIRE OR ELECTRIC SHOCK, DO NOT EXPOSE THIS EQUIPMENT TO RAIN OR MOISTURE.

TO REDUCE THE RISK OF FIRE OR ELECTRIC SHOCK, AND ANNOYING INTERFERENCE, USE THE RECOMMENDED ACCESSORIES ONLY.

THIS DEVICE IS INTENDED FOR CONTINUOUS OPERATION!

CAUTION	-LASER RADIATION WHEN OPEN. DO NOT STARE INTO BEAM.
ATTENTION	-RAYONNEMENT LASER EN CAS D'OUVERTURE. NE PAS REGARDER DANS LE FAISCEAU.
VORSICHT	-LASERSTRAHLUNG, WENN ABDECKUNG GEÖFFNET. NICHT IN DEN STRAHL BLICKEN.
ADVARSEL	-LASERSTRÅLING VED ÅBNING. SE IKKE INN I STRÅLEN.
ADVARSEL	-LASERSTRÅLING NÅR DEKSEL ÅPNES. STIRR IKKE INN I STRÅLEN.
VARNING	-LASERSTRÅLNING NÅR DENNA DEL ÅR ÖPPNAD. STIRRA EJ IN I STRÅLEN.
VARO!	-AVATTAESSA OLET ALLTIINA LASERSÄTEILYLLE. ÄLÄ TUJOTA SÄTEESEEN.
注意	- 当打开这里会出现激光, 请不要直视激光。
注意	- ここを開くとレーザー光が出ます。 レーザー光をのぞき込まないでください。

(Inside of product)

**CLASS 1
LASER PRODUCT**

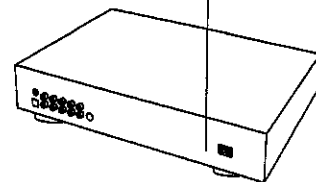

(Back of product)

Dear Customers

May we take this opportunity to thank you for purchasing this Panasonic DVD/VIDEO/CD player.

We strongly recommend that you carefully study the Operating Instructions before attempting to operate the unit and that you note the listed precautions.

Features

■ DVD: a completely new dimension in video entertainment

- Subtitles may be displayed in one of a maximum of 32 languages*.
- The audio soundtrack can be heard in up to 8 languages*.
- The multi-angle function allows you to choose the viewing angle of scenes which were shot from a number of different angles. (Limited to DVD recorded with multiple camera angles.)

*The number of the languages recorded is dependent on the software.

■ High quality digital audio

- The Dolby Digital (AC-3)/MPEG 2 audio/Linear PCM decoder is built into the player which makes it possible to enjoy Multi-Channel Surround sound.
- With the linear PCM sound of a 48 kHz/16 bit through 96 kHz/24 bit, audio quality exceeding that of CDs becomes possible.

■ Many convenient features

- GUI (Graphical User Interface) screens for showing the disc information or player information and providing access to many major functions of this unit
- Reproducing a virtual surround effect even when only a 2-channel stereo system is connected. [Dolby Digital (AC-3) 5.1ch DVD only]
- Programming of up to 5 scenes in memory (markers)
- Parental lock settings to prevent play of discs unsuitable for some audiences [DVD only]
- The remote control unit supplied has an easy-to-use joystick, and it can control the TV as well.

■ Compatible with PAL DVD (Video CD) and NTSC DVD (Video CD)

- This player can play discs recorded in either PAL or NTSC format.

However, the player must be connected to a PAL TV which is capable of receiving PAL 525/60 system to play both PAL DVD (Video CD) and NTSC DVD (Video CD).

■ Compatible with Video CD and CD as well as DVD

■ Disc formats supported by this player

The unit can play back discs bearing any of the following marks:



DVD
[8 cm disc/
12 cm disc]



Video CD
[8 cm disc/
12 cm disc]



CD
[8 cm disc/
12 cm disc]

DVD-A350A Contents



Please check and identify the supplied accessories.

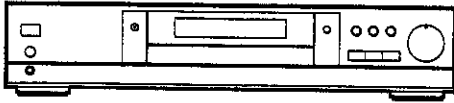

DVD-A350A
Main unit 1

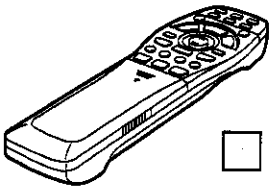

Remote control
unit 1
(Parts No. VEQ2084)

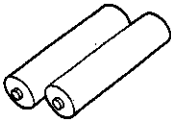

Batteries 2
for remote control unit
[size "AA" (R6P)]

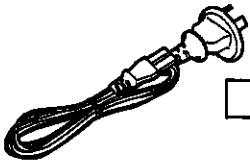

AC mains lead 1
(Parts No. VJA0754)

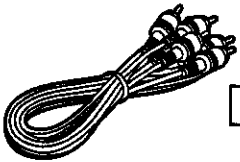

Video/audio
cord 1
(Parts No. VJA0788-D)

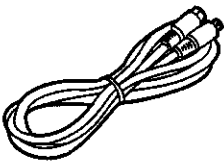

S-video cord 1
(Parts No. VJA0658-A)

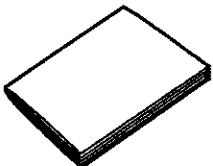

Operating Instructions
manual 1
(Parts No. VQT7410)

Table of contents

Getting Started:

Safety information	2
Features	3
DVD-A350A Contents	4
Precautions	6
Control reference guide	7
Front panel display	9
Basic connection	10
Optional video connections	11
Optional audio connections	12
Remote control preparation	14
Connecting headphones	14
Before enjoying DVD/Video CD/CD	15

Basic Operation:

Basic play	15
•Basic play	15
•Stopping play	17
•Skipping ahead or back	17
Rapid advance (Rapid reverse)	18
Still picture (Pause)	18
Frame advance [DVD/Video CD]	18
Slow-motion play [DVD/Video CD]	19
Enjoying Video CDs with playback control without using menus [Video CD only]	19

Operation Using GUI Screens:

General information about GUI screens	20
•Common procedures	20
Detailed descriptions of each GUI icon	21
•Screen for disc information	21
•Screen for player information	22
•Screen for slow-motion play and rapid advance (reverse)	22

Advanced Operation:

Program play [Video CD/CD]	23
Random play [Video CD/CD]	24
Repeat play	25
•Repeat viewing (listening)	25
•Repeating sections between two specific points (A-B repeat)	26
Storing markers in memory to be viewed (listened) again	27
•Storing a marker in the memory	27
•Recalling/clearing a marker	27
Changing subtitle language [DVD only]	28
Changing audio soundtrack language [DVD only]	29
Switching vocals ON or OFF for Karaoke discs [DVD/Video CD]	29
Viewing from another angle [DVD only]	30
Reproducing a virtual surround effect [Dolby Digital (AC-3) 5.1ch DVD only]	30
Using a title menu [DVD only]	31
Using a DVD menu [DVD only]	31

Initial Settings:

Initial settings	32
•Common procedures of initial settings	32
•Selecting disc languages [DVD only]	33
•Selecting rating level [DVD only]	34
•Selecting language of On-Screen Display menu	35
•Switching the On-Screen Display ON or OFF	36
•Selecting the display brightness	36
•Selecting TV screen type	37
•Selecting digital output	38
•Speaker setting	39
•Other settings	41

For Your Reference:

Operating the TV set by the remote control unit	42
Disc handling and maintenance	43
Troubleshooting	44
Self-diagnosis display function	45
Definition of terms	46
Specifications	46
Language code list	47
Region Management Information	Back cover

Precautions

Please read these precautions before operating this unit.

■ Mains lead protection

To avoid any malfunctions of the unit, and to protect against electric shock, fire or personal injury, please observe the following.

- Hold the plug firmly when connecting or disconnecting the AC mains lead to this unit.
- Do not connect or disconnect the AC mains lead when your hands are wet.
- Keep the AC mains lead away from heating appliances.
- Never put any heavy object on the AC mains lead.
- Do not attempt to repair or reconstruct the AC mains lead in any way.
- Remove dust, dirt, etc. on the plug at regular intervals.
- If the unit has been dropped or otherwise damaged, turn off the power and disconnect the AC mains lead.
- If smoke, malodors or noises are emitted from the unit, turn off the power and disconnect the AC mains lead.

■ Placement

Avoid placing the unit in areas of:

- direct sunlight or heating radiators, or closed automobiles
 - high temperature (over 35°C) or high humidity (over 90%)
 - excessive dust
 - vibration, impact or where the surface is tilted
- As the internal parts may be seriously damaged.

■ Non-use Periods

When the unit is not being used, switch the unit to the stand-by mode.

When left unused for a long period of time, the unit should be unplugged from the household AC outlet.

■ No fingers or other objects inside

- Touching internal parts of this unit is dangerous, and may cause serious damage to the unit. Do not attempt to disassemble the unit.
- Do not put any foreign object on the disc tray.

■ Keep away from water and magnets.

- Keep the unit away from flower vases, tubs, sinks, etc. If liquids are spilled into the unit, serious damage could occur.
- Never bring magnetic objects such as speakers near to this unit.

■ Stacking

- Place the unit in a horizontal position, and do not place anything heavy on it.
- Do not place the unit on amplifiers or other equipment which may become hot.

■ Condensation

Moisture may form on the lens in the following conditions...

- immediately after a heater has been turned on.
- in a steamy or very humid room.
- when the unit is moved from a cold environment to a warm one.

If moisture forms inside this unit, it may not operate properly. In this case, turn on the power and wait about one hour for the moisture to evaporate.

■ If there is noise interference on the TV while a broadcast is being received

Depending on the reception condition of the TV, interference may appear on the TV screen while you are watching a TV broadcast and the unit is left on. This is not a malfunction of the unit or the TV. To watch a TV broadcast, switch this unit to standby mode.

Control reference guide

Main unit

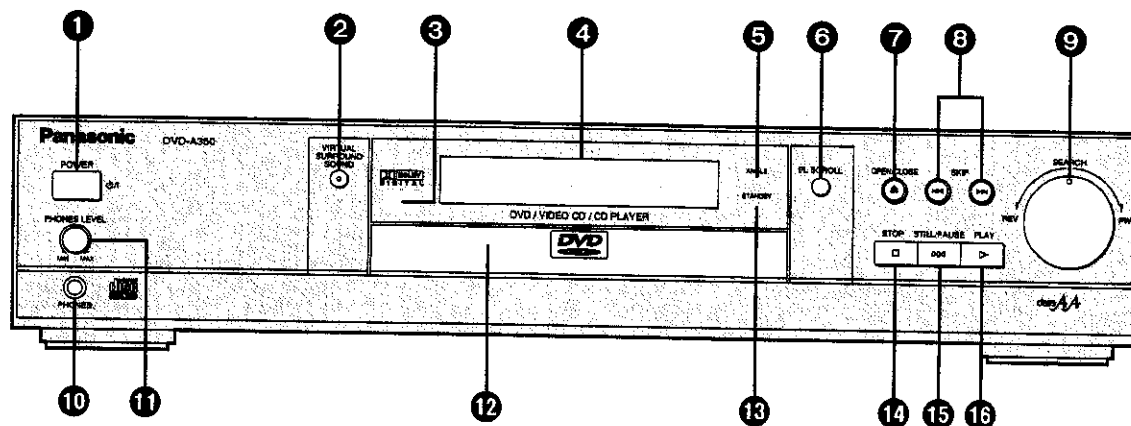

Page

1	POWER, \odot/I button	15
	Press to switch the unit from on to standby mode or vice versa. In standby mode, the unit is still consuming a small amount of power.	
2	VIRTUAL SURROUND SOUND button/indicator	30
3	Remote control signal sensor	14
4	Display window	9
5	ANGLE indicator	30
6	FL SCROLL button	
	Press to show the audio information for the disc currently being played on the unit's display.	
7	OPEN/CLOSE button	15

Page

8	SKIP buttons	16, 17
9	Shuttle dial (SEARCH)	18, 19
10	PHONES jack	14
11	PHONES LEVEL control	14
12	Disc tray	15
13	STANDBY indicator	
	When the unit is connected to the AC mains supply, this indicator lights up in standby mode and goes out when the unit is turned on.	
14	STOP button	17
15	STILL/PAUSE button	18
16	PLAY button	15

Control reference guide



Remote control unit

Page

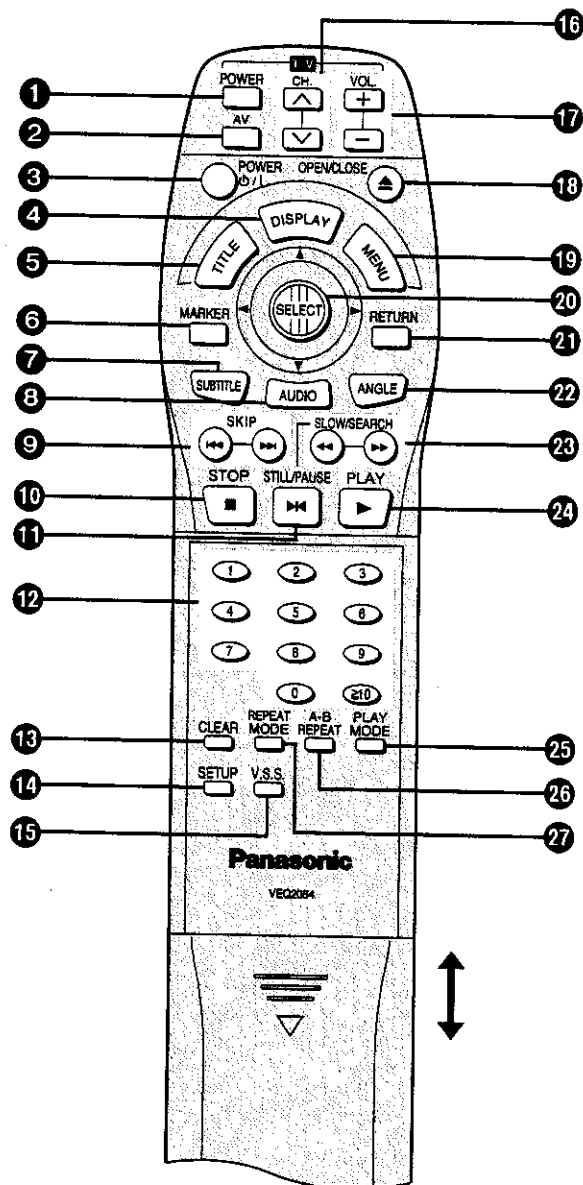
1	TV POWER button	42
2	TV AV button	42
3	POWER \odot/I button (for DVD/VIDEO CD/CD player)	15
4	DISPLAY button	20
5	TITLE button	16, 31
6	MARKER button	27
7	SUBTITLE button	28
8	AUDIO button	29
9	SKIP buttons	16, 17
10	STOP button	17
11	STILL/PAUSE button	18
12	Numeric buttons	16
	•To select a 2-digit number	
	Example: To select track 23	
	Press "2", "3" and then "3".	
13	CLEAR button	20, 24, 27, 33
14	SETUP button	32
15	V.S.S. button	30
16	TV CH. buttons	42
17	TV VOL. buttons	42
18	OPEN/CLOSE button	15
19	MENU button	16, 19, 31
20	Joystick/SELECT button	16
21	RETURN button	16, 20
22	ANGLE button	30
23	SLOW/SEARCH buttons	18, 19
24	PLAY button	15
25	PLAY MODE button	23, 24
26	A-B REPEAT button	26
27	REPEAT MODE button	25



Front panel display

- ①  Rotates during play.
Rotates fast clockwise or counterclockwise during rapid advance (reverse). (See page 18.)
Rotates slowly clockwise or counterclockwise during slow-motion play.
[DVD/Video CD] (See page 19.)
-  Illuminates in the stop mode.
- ② Illuminates during playback.
Flashes when the RESUME function is ON.
(See page 17.)
- ③ Illuminates during repeat play. (See page 25.)
- ④ Illuminates in the pause mode. [CD] (See page 18.)
- ⑤ Indicates the chapter number. [DVD]
Indicates the track number. [Video CD/CD]
- ⑥ Indicates the total playing time when the disc tray is closed. [Video CD/CD]
Indicates the elapsed playing time from the start of the title/track during play.
- ⑦ Indicates the current audio channel information recorded in the disc (e.g. 2ch or 5.1ch).
- ⑧ Illuminates when a DVD is loaded.
- ⑨ Illuminates in the still picture mode.
[DVD/Video CD] (See page 18.)
- ⑩ Illuminates during program play. [Video CD/CD]
(See pages 23 and 24.)
- ⑪ Illuminates when Linear PCM of 96 kHz sampling is being played.
- ⑫ Illuminates when Linear PCM of 24 bit is being played.
- ⑬ Illuminates when the disc tray is open.
- ⑭ Illuminates when the disc tray is being closed (retracted).
- ⑮ Illuminates during play of a DVD.
- ⑯ Illuminates during play of an interactive DVD.
- ⑰ Illuminates during play of a Karaoke DVD.
- ⑱ Illuminates during play of an interactive Karaoke DVD.
- ⑲ Illuminates during play of a Video CD.
- ⑳ Illuminates during play of a Video CD with playback control.
- ㉑ Illuminates during play of a CD.
- ㉒ Illuminates when playback is impossible.
 - DVDs for which playback is prohibited by the setup "Ratings". (See page 34.)
 - DVDs with Region No. other than "4" or "ALL". (See page 43.)
- ㉓ Illuminates when no disc is loaded.

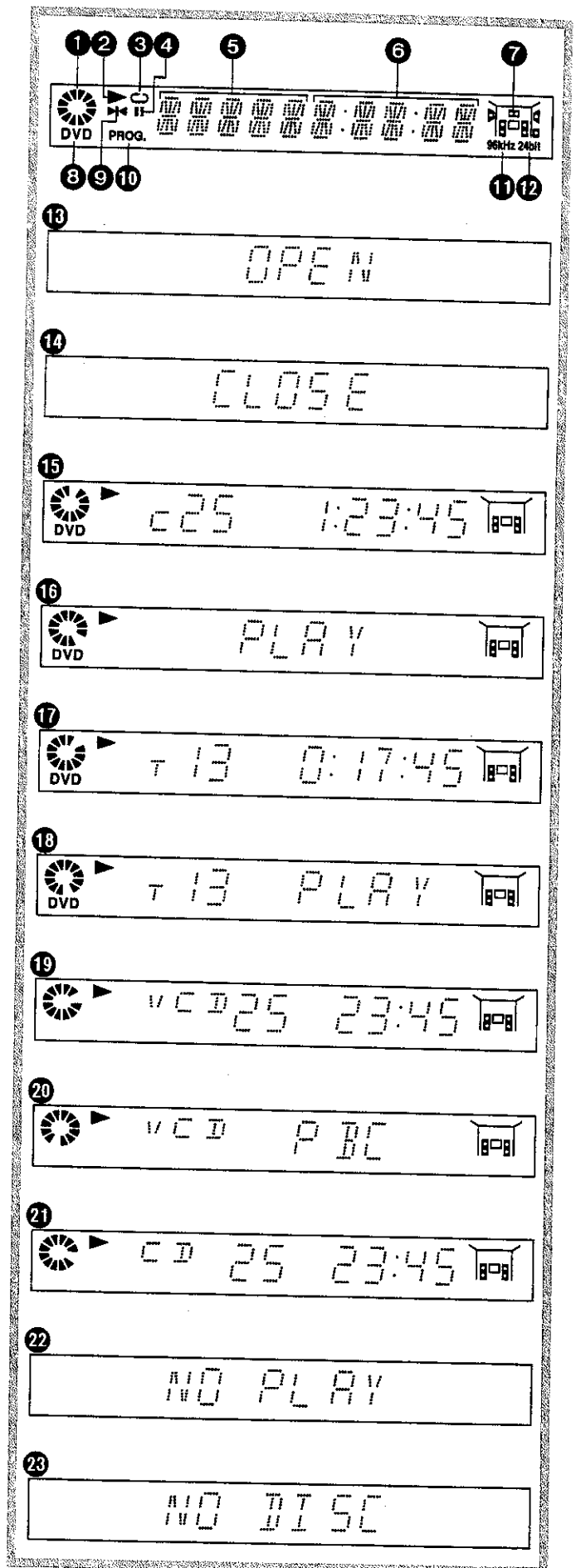

Basic connection

- Ensure that the power switch of this unit and other equipment to be connected is set to off before commencing connection.
- Do not block ventilation holes of any of the equipments and arrange them so that air can circulate freely.
- Read through the instructions before connecting other equipment.
- Ensure that you observe the colour coding when connecting audio and video cords.

Connecting to a TV set and an audio equipment

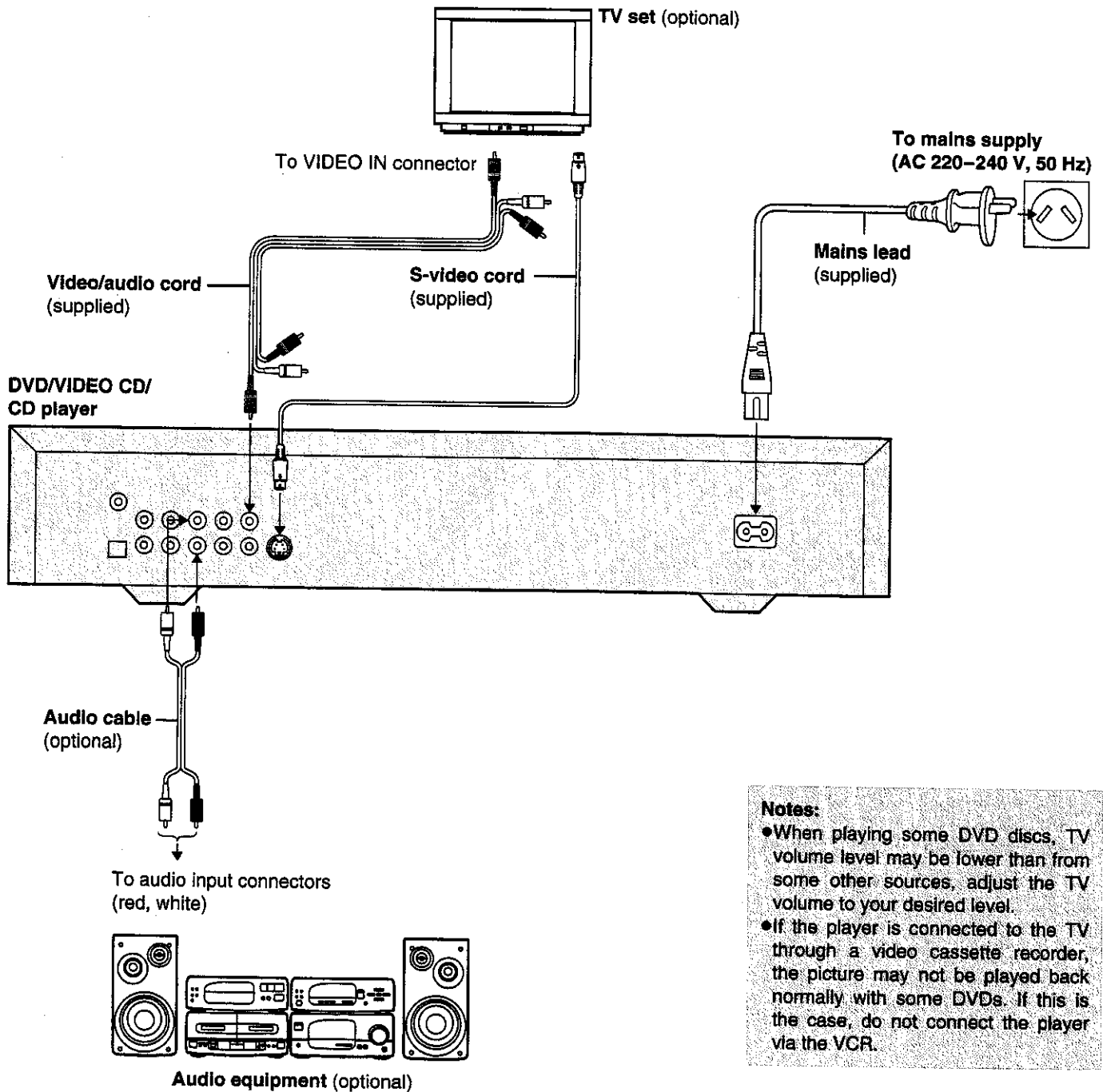

Optional video connections

Connecting to a TV set with an S-video input connector

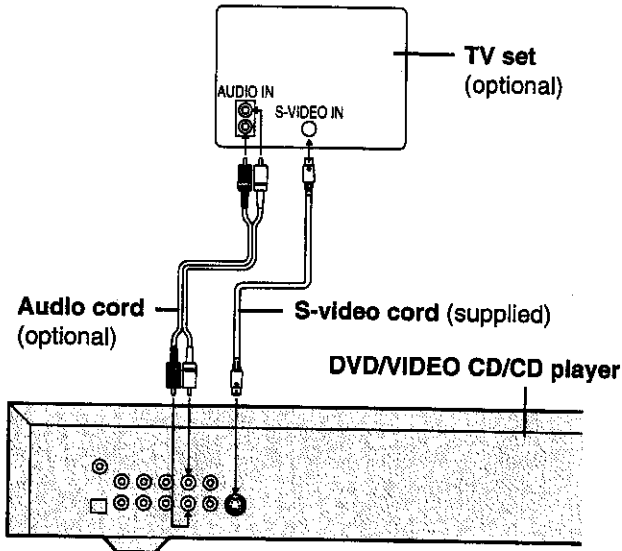

S-video output connector

The S (separate) video output connector separates the color (C) and luminance (Y) signals before transmitting them to the TV set in order to achieve a sharper picture. Use the S-video cord (optional) when connecting the player to a TV set equipped with an S-video input connector for the best possible picture quality.

Connecting to a TV set with Video/audio cord

■ If the TV set is stereo

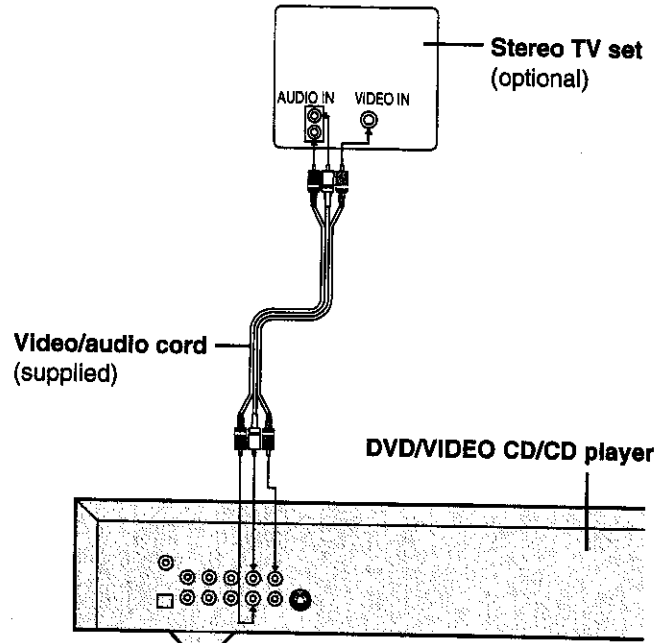

■ If the TV set is monaural

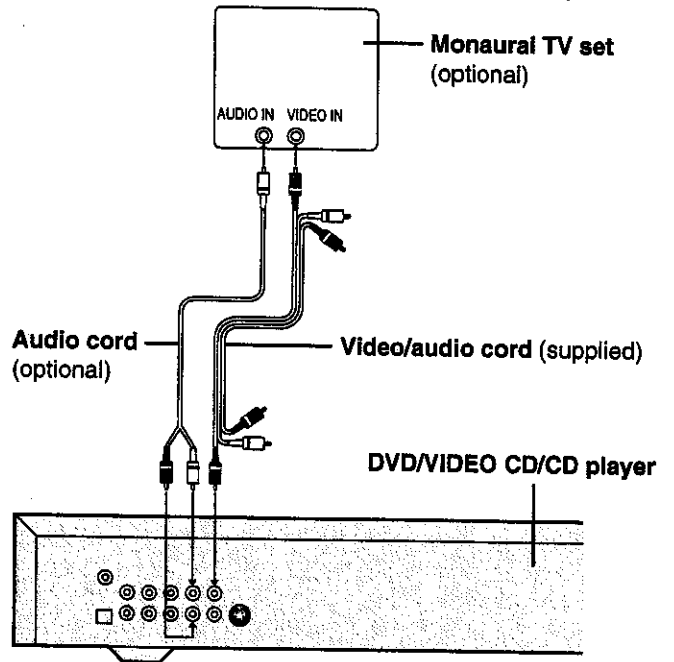

Optional audio connections

Connecting to an AV amplifier with 5.1ch input connectors supporting Dolby Digital (AC-3) or MPEG 1/2

This player contains a Dolby Digital (AC-3) decoder or MPEG 2 decoder. This enables the playback of DVDs recorded in Dolby Digital, MPEG 1/2 audio or Linear PCM without the need for an external decoder with Dolby Digital, MPEG 1/2 audio or Linear PCM processing. When the player is connected to an AV amplifier with 5.1ch input connectors, you can enjoy theater-quality audio in your home when playing discs recorded in Dolby Digital, MPEG 1/2 audio or Linear PCM.

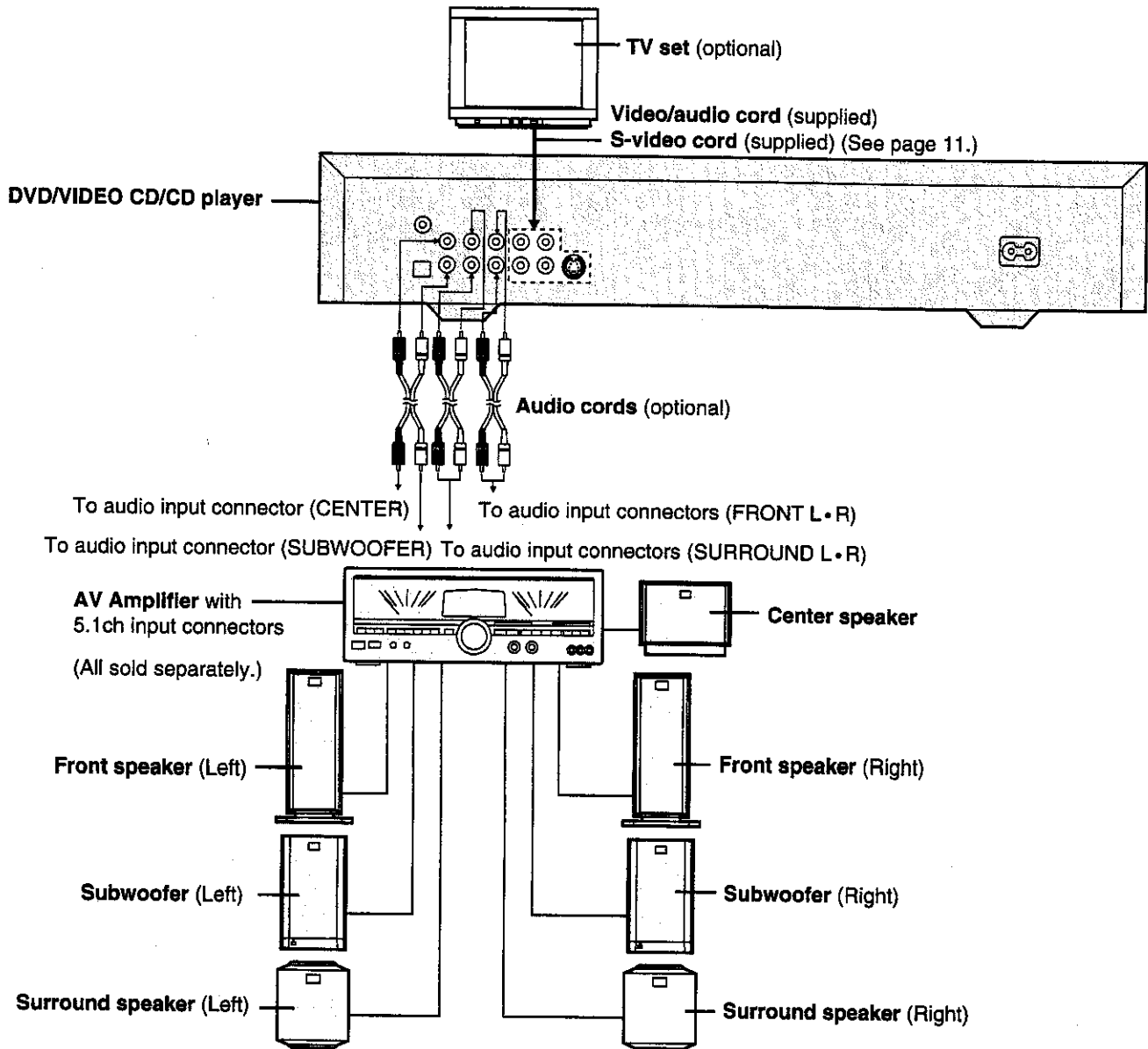

Notes:

- After connection is made, set the "Speaker setting" (such as Yes/No and Large/Small) according to your speaker system. (See page 39.)
- If the type of the speakers connected does not satisfy the channels recorded in an MPEG 2 or Linear PCM disc, the disc will not be played in all the channels but only in 2 channels. (For example, even if the front speakers and the center speaker are connected, a disc recorded in 5 channels will be played back only in 2 channels.)
- DVDs recorded in Linear PCM/96 kHz sampling in which "Center Speaker" is contained will also be played back only in 2ch.

- If the surround speakers or the center speaker can't be installed at an equal distance to (or further away from) the front speakers from the listening position, then change the delay time setting at the "Speaker setting" on page 39, to compensate.
- Set VIRTUAL SURROUND SOUND (V.S.S.) to "VSS OFF" (Cancel) when using speakers other than the front speakers (L/R). If it is set to "VSS 1" (Natural effect) or "VSS 2" (Emphasized effect), sound will be delivered only through the front speakers (L/R).

Optional audio connections

Connecting to a decoder with Dolby Digital (AC-3) processing or MPEG processing

When DVDs recorded in Dolby Digital or MPEG audio are played, Dolby Digital bitstream or MPEG audio bitstream is output from the player's OPTICAL digital audio output connector or COAXIAL digital audio output connector. When the player is connected to a Dolby Digital decoder or MPEG audio decoder, you can enjoy theater-quality audio in your home. [An optical digital cable or coaxial audio cable (both optional) is required when an optional Dolby Digital decoder or MPEG audio decoder is used.]

Notes when connecting the optical digital cable (optional)

- Remove the dust protection cap from the connector and connect the cable firmly so that the configurations of both the cable and the connector match (B).
- Keep the dust protection cap and always reattach the cap when not using the connector to protect against dust.

Concerning the audio output from the unit's optical/coaxial digital audio output connector

Disc	Sound recording format	Optical/coaxial digital audio output from connector
DVD	Dolby Digital (AC-3)	Dolby Digital bitstream (2-5.1ch) or PCM (2ch) (48 kHz/16 bit) ^{*1}
	Linear PCM (48/96 kHz 16/20/24 bit)	Linear PCM (2ch) (48 kHz sampling/16 bit only) ^{*2} or no output ^{*1}
	MPEG 1/MPEG 2	MPEG audio bitstream or PCM (2ch) (16 bit) ^{*1}
Video CD	MPEG 1	PCM (44.1 kHz sampling)
CD	Linear PCM	Linear PCM (44.1 kHz sampling)

^{*1}The type of audio output from the connector can be selected by the initial settings. (See page 38.)

^{*2}Sound having 96 kHz sampling is converted into 48 kHz sampling when it is output from the unit's optical/coaxial digital audio output connector.

For your reference:

- Dolby Digital (AC-3) is a digital sound compression technique developed by the Dolby Laboratories Licensing Corporation. Supporting 5.1-channel surround sound, as well as stereo (2-channel) sound, this technique enables a large quantity of sound data to be efficiently recorded on a disc.
- Linear PCM is a signal recording format used in CDs. While CDs are recorded in 44.1 kHz/16 bit, DVDs are recorded in 48 kHz/16 bit up to 96 kHz/24 bit.
- If you have a Dolby Pro Logic Surround decoder, you will obtain the full benefit of Pro Logic from the same DVD movies that provide full 5.1-channel Dolby Digital soundtracks, as well as from titles with the Dolby Surround mark.

Caution for the optical/coaxial digital audio output connector:

- Do not connect an amplifier (with an optical/coaxial digital input connector) which does not contain the Dolby Digital (AC-3) or MPEG audio decoder.
- Otherwise any attempt to play DVDs may cause such a high level of noise that it may be harmful to your ears and damage your speakers.
- Video CDs and CDs can be played as they would normally be played.

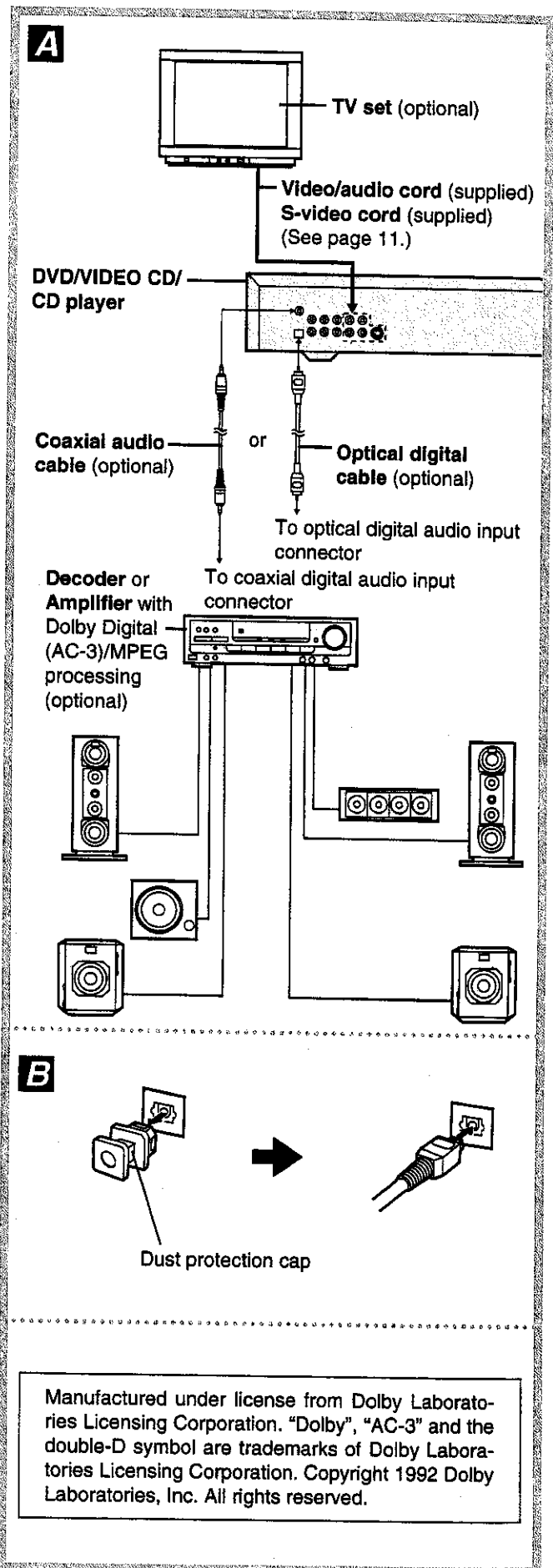

Remote control preparation

Battery installation **A**

Insert the batteries while observing the correct (+) and (-) polarities as illustrated at right.

Service life of batteries

- The batteries normally last for about one year although this depends on how often and for what operations the remote control is used.
- If the remote control unit fails to work even when it is operated near the player, replace the batteries.
- Use size "AA", R6P batteries.

Notes:

- Do not use rechargeable (Ni-Cd) batteries.
- Do not attempt to recharge, short-circuit, disassemble, heat or throw the batteries into the fire.
- Do not drop, step on or otherwise impact the remote control unit. This may damage the parts or lead to malfunction.
- Do not mix old and new batteries.
- If the remote control unit is not going to be used for a long time, remove the batteries. Otherwise, electrolyte may leak which may lead not only to malfunctioning but also to burns if contact is made with the electrolyte.
- Wipe away any electrolyte leaking inside the remote control unit, and install new batteries.
- If any electrolyte should come into contact with parts of your body, wash it off thoroughly with water.

Remote control operation range **B**

Point the remote control unit no more than about 7 m from the remote control sensor and within about 60° of the front of the unit.

- The operating distance may vary according to the brightness of the room.

Notes:

- Do not point bright lights at the remote control sensor.
- Do not place objects between the remote control unit and the remote control sensor.
- Do not use this remote control unit while simultaneously operating the remote control unit of any other equipment.

Connecting headphones **C**

1 Connect the headphones.

- Headphones with a stereo plug (M6) can be connected.

2 Adjust the volume.

Caution:

Avoid listening to sound at levels which may be harmful to your ears.

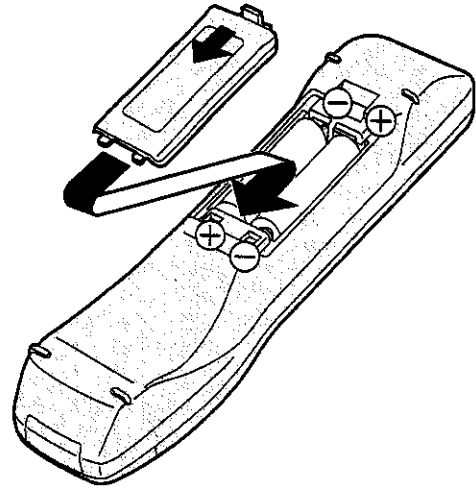
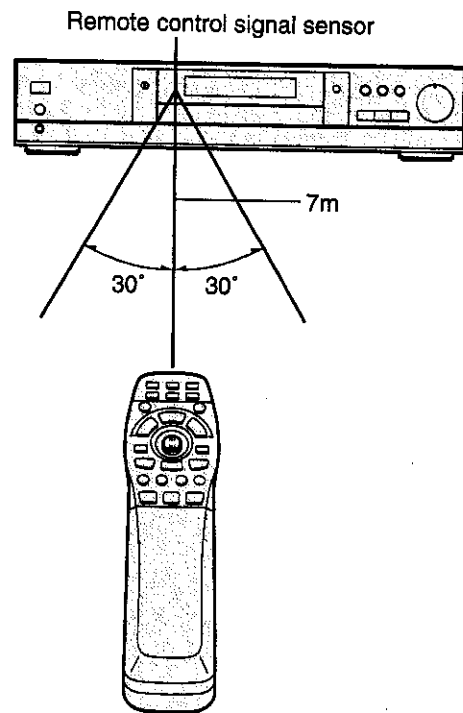
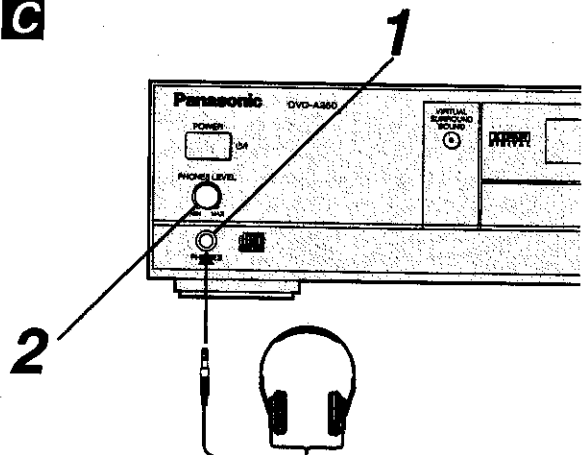
A**B****C**

Before enjoying DVD/Video CD/CD

The On-Screen menu language of your player has been factory pre-set to English.

If you would like to change the menu language to French, Spanish, German or Italian, please refer to "Selecting language of On-Screen Display menu" on page 35.

If the explanations given below it is assumed that English has been selected as the menu language.

Basic play

Preparations

- Switch the TV ON and select "Video" as the TV input.
- Switch on the stereo system's power if the player has been connected to a stereo system.

Basic play

1 Press Power to switch on the power.

2 Press OPEN/CLOSE to open the disc tray.

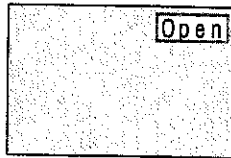

3 Place a disc onto the disc tray.

Hold the disc without touching either of its surfaces, position it with the printed title side facing up, align it with the guides, and place it in its proper position.

- ① 8 cm disc
- ② 12 cm disc

4 Press PLAY.

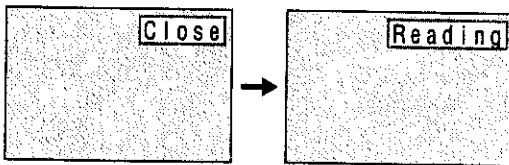

The disc tray is automatically closed and play begins.

• When the disc tray is closed by pressing OPEN/CLOSE, press PLAY to commence play.

• When a menu screen appears on the TV monitor

In case of DVDs with menu or Video CDs with playback control, a menu screen appears on the TV monitor. Perform step 5 on page 16 to commence play.

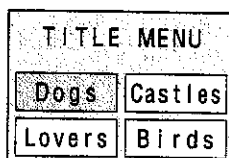

(Example of DVD)

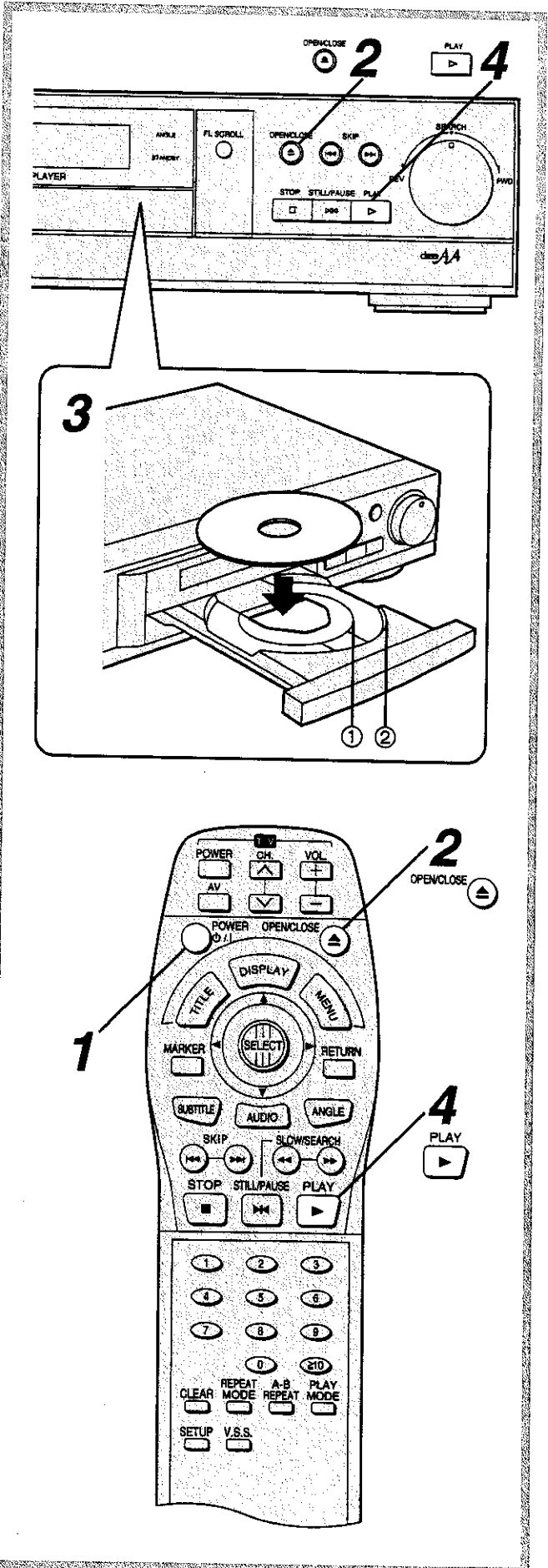

(Continued on the next page)

Basic play

- 5** Tilt the joystick to the ◀/▶/▲/▼ direction and press SELECT, or press the numeric button(s), to select the preferred item.

• The joystick is not effective for selecting items for Video CDs.

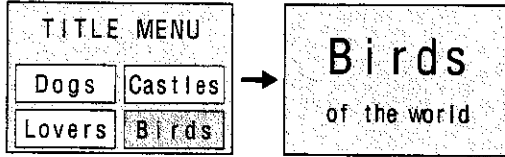

Play of the selected item now begins.

When the menu continues onto another screen

After step 4 on page 15, press SKIP ▶▶.

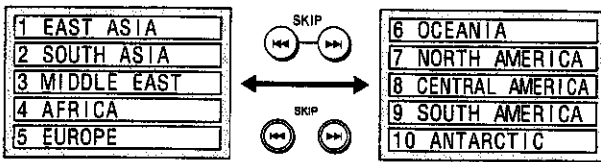

- To return to the previous menu screen Press ◀◀ SKIP.
- For operation, refer also to the jacket of the disc concerned.

Stopping play and returning to the menu screen

- **DVD**
Press TITLE, MENU or RETURN.
(Which button is pressed differs depending on the disc used.)
- **Video CD**
Press RETURN.
- Play is suspended, and the menu screen is displayed.

After operation

When the unit is not in use, remove the disc and press POWER to switch the power to the standby mode. The power will automatically be switched to the standby mode after 30 minutes or so have elapsed in the stop mode. **(Auto power-off function)**

What is playback control?

If a Video CD has "playback control" written on its disc or jacket, it means that particular scenes or information can be selected for viewing interactively with the TV monitor using the menu screen.

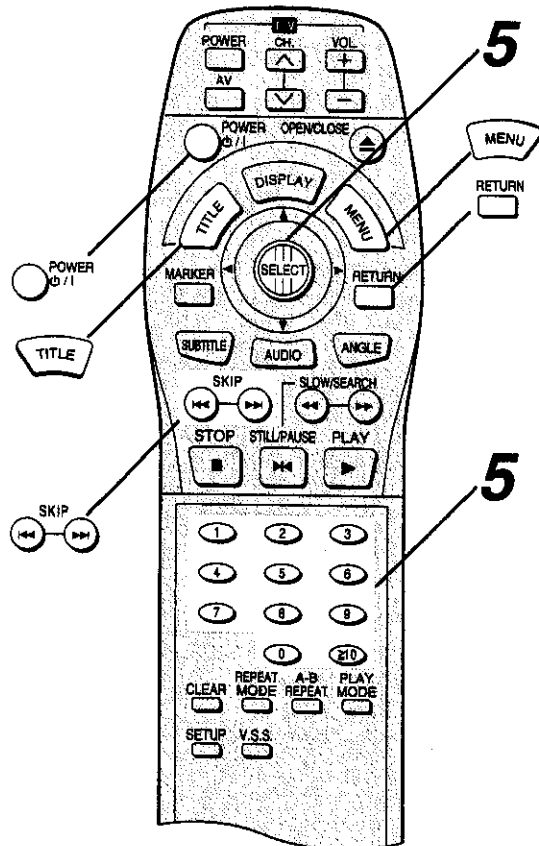
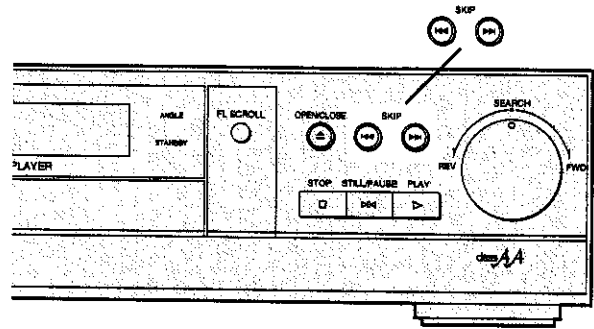

Basic play

Note:

- The disc continues to rotate while the menu is displayed even after the player has finished playing a particular item. When no further selections are to be played, be sure to press the STOP button to clear the menu display.
- If the disc is placed in upside down (and it is a single sided disc), the DVD display will indicate "NO DISC".
- When the NTSC DVD/Video CD is played, the playback picture may roll up or down on some TVs; adjust this using the V-HOLD control on the TV. TVs not equipped with a V-HOLD control cannot correct this condition. The playback picture may shrink vertically and black bars may appear both on the top and bottom of the screen, or the picture may be in black and white. This does not indicate a malfunction.

For your reference:

- When  appears while a button is being operated, it means that the corresponding operation is prohibited by the player or the disc.

Stopping play

Press STOP.

For your convenience:

- When play is stopped, the unit records the point where STOP was pressed (**RESUME function**). ("" flashes on the unit's display when this function is activated.) Press PLAY again, and play will resume from this point. When the tray is opened or STOP is pressed again, the RESUME function will be cleared.

The RESUME function works only with discs for which the elapsed playing time appears on the unit's display during playback.

This feature will not be cleared when the power is switched to the standby mode and then returned to ON.

Skipping ahead or back

Skipping ahead

Press SKIP during play.



A chapter (DVD) or a track (Video CD/CD) is skipped each time the button is pressed.

Skipping back

Press SKIP during play.

When the button is pressed once midway through a chapter/track, play returns to the start of that chapter/track. When it is pressed again, a chapter/track is skipped each time the button is pressed.

For your reference:

- When  SKIP  is pressed during menu play of Video CDs, a menu screen may sometimes be recalled.

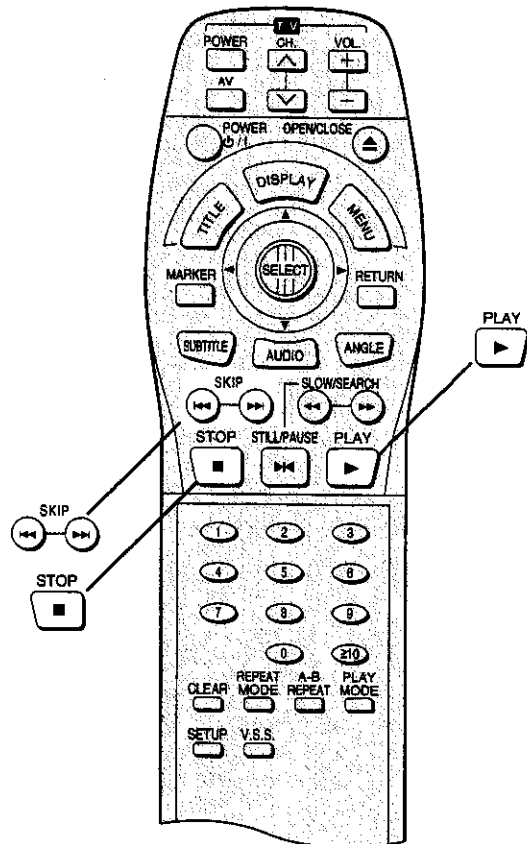
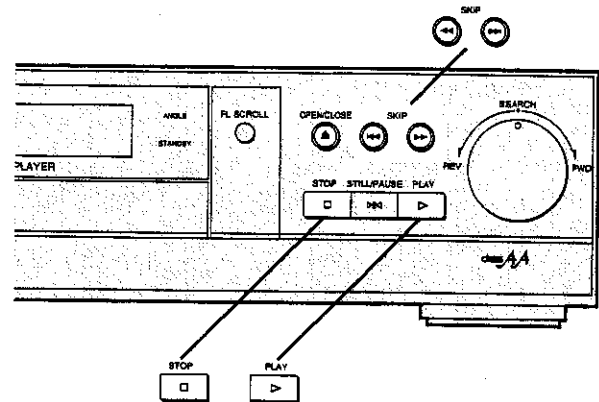

Rapid advance (Rapid reverse)

By the remote control unit

Press **SLOW/SEARCH** ◀◀ or ▶▶ during play.

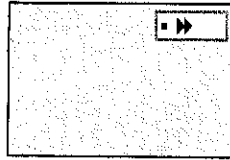
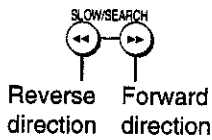

(Example)

- The speed of advance (reverse) is relatively slow at first. When the button is pressed again, the speed becomes faster. (Each time the button is pressed, the speed increases up to 5 steps.)

To return to normal play

Press **PLAY**.

On the main unit

Turn the shuttle dial during play.

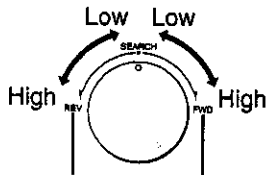

Reverse direction Forward direction

- The speed increases up to 5 steps.
- Normal play is resumed when the shuttle dial is released.

For your reference:

- When SLOW/SEARCH or the shuttle dial is used during menu play of Video CDs, a menu screen may sometimes be recalled.

Still picture (Pause)

Press **STILL/PAUSE** during play.

- DVD/Video CD:

The player will be placed in the still picture mode.

- CD:

The player will be placed in the pause mode.



[DVD/Video CD]

To return to normal play

Press **PLAY**.

Frame advance [DVD/Video CD]

Press **STILL/PAUSE** in the still picture mode.

The disc is advanced by one frame each time the button is pressed.

- When the button is kept pressed, consecutive frame advance works.

To return to normal play

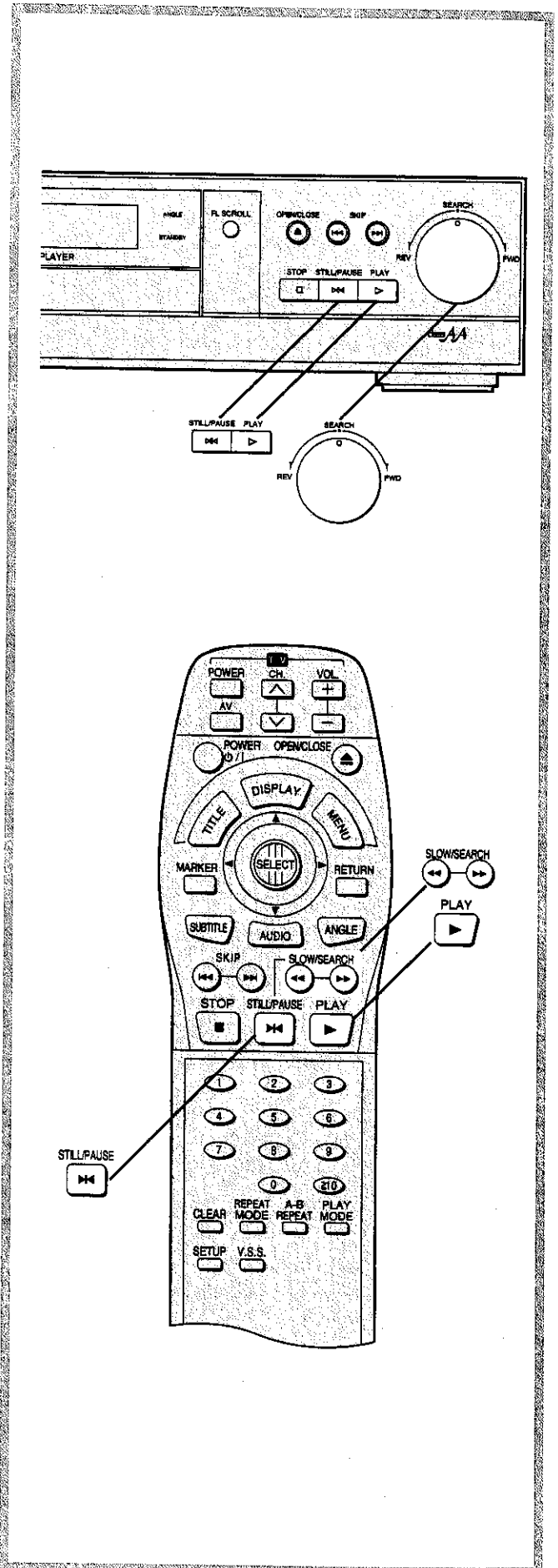

Slow-motion play [DVD/Video CD]

By the remote control unit
Press **SLOW/SEARCH** ◀◀ or ▶▶ in the still picture mode. (See page 18.)

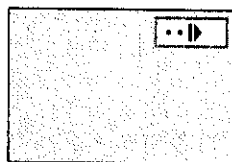
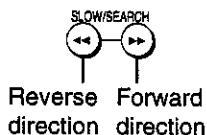

(Example)

- The speed of slow-motion is slow at first. When the button is pressed again, the speed becomes faster. (Each time the button is pressed, the speed increases up to 5 steps.)

To return to normal play
Press **PLAY**.

On the main unit
Turn the shuttle dial in the still picture mode.
(See page 18.)

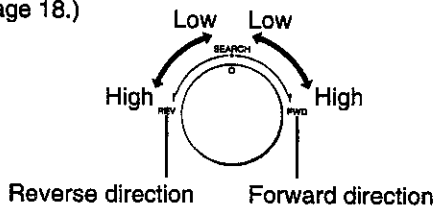

- The speed increases up to 5 steps.
- Still picture mode is resumed when the shuttle dial is released.

For your reference:

- For Video CDs, slow-motion playback in reverse direction is not possible.

Enjoying Video CDs with playback control without using menus [Video CD only]

1. Press **STOP** after the menu screen appears (after step 4 on page 15).
(“PBC” will be cleared from the unit’s display.)
2. Press the numeric button(s) to select the preferred track.
(Play begins.)
 - Refer to the jacket etc. of the disc concerned for the track numbers.
 - Press “1” to start play from the beginning of the disc.

To return to menu play

Press **STOP** to stop playback and press **MENU**.
(“PBC” will light up on the unit’s display and the menu screen is resumed.)
Perform step 5 on page 16.

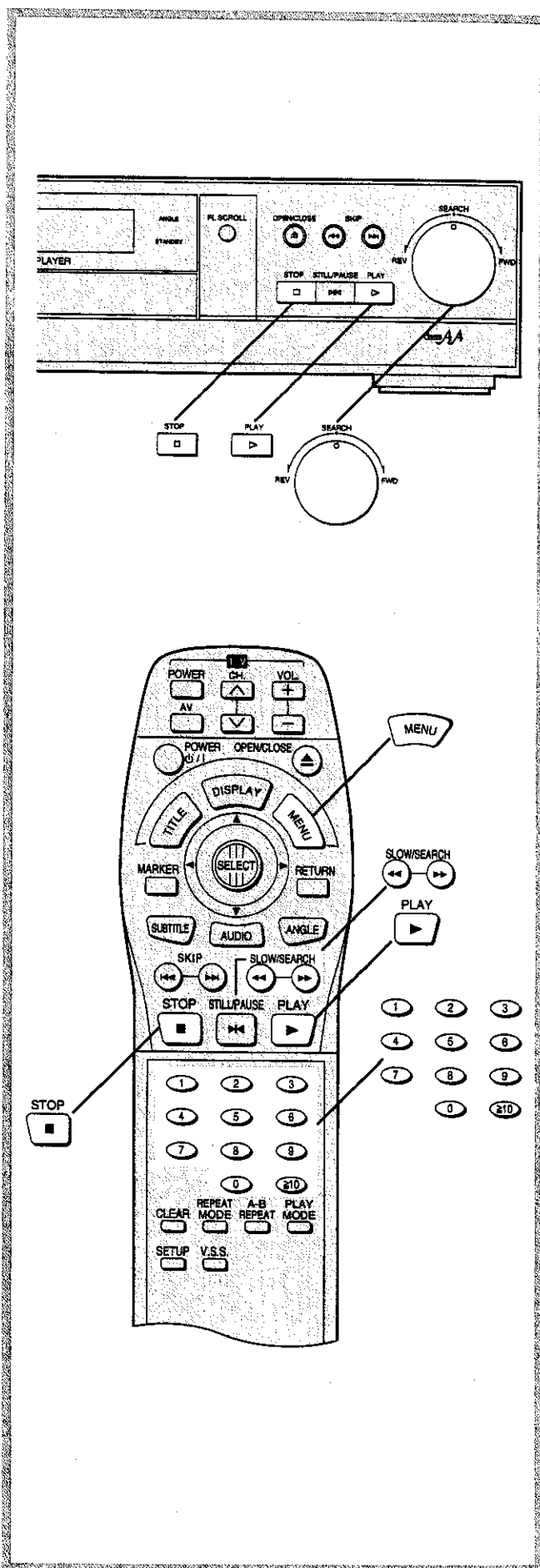

General information about GUI screens

This unit features GUI (Graphical User Interface) screens consisting of icons showing disc information (title/chapter/track number, elapsed playing time, audio/subtitle language, and angle) and player information (repeat play, play mode, marker, picture mode, Karaoke vocal ON/OFF, master volume, etc.).

Some icons only show the indicated information. Other icons allow the settings to be changed.

Common procedures

1 Press DISPLAY during play or in the stop mode.

Each time this button is pressed, the TV monitor changes as shown below.

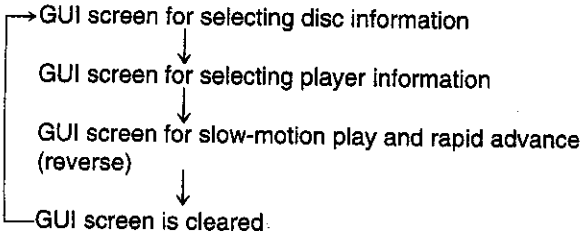

•Some functions cannot be accessed from the stop mode.

2 Tilt the joystick to the ◀/▶ direction to select the preferred item.

•The currently selected item is indicated by the yellow frame on the GUI screen.

3 Tilt the joystick to the ▲/▼ direction to select the preferred setting.

•When numbers are displayed (e.g. title No.), the numeric buttons are also effective for setting instead of the joystick.

•For some functions, the setting will be registered immediately; for others, SELECT must be pressed.

Press DISPLAY, RETURN or CLEAR to clear the GUI screen.

Example of GUI screens

(The screens may differ depending on the disc contents.)

- DVD (E)
- Video CD (G)
- CD (D)

For your reference:

•Depending on the type of DVD software and a TV with automatic picture zoom function enabled, the GUI screen may not be displayed or only partially displayed on the TV screen.

In this case, select the appropriate TV screen type by consulting the operation manual of the TV.

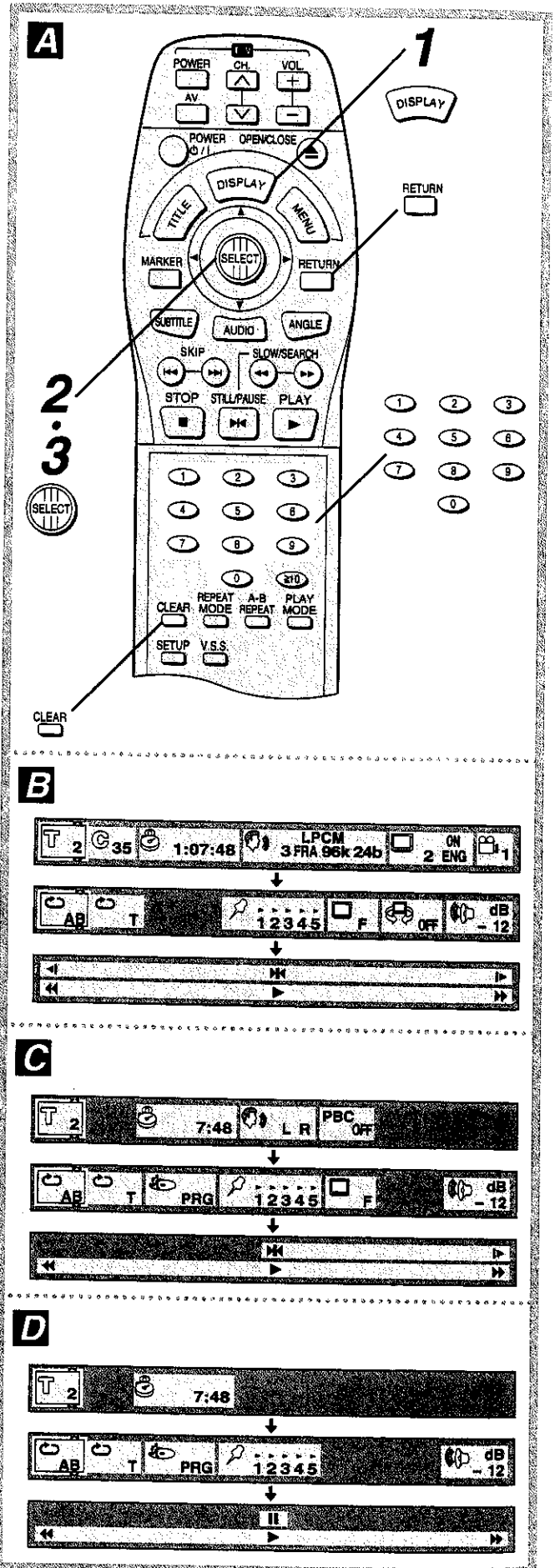

Detailed descriptions of each GUI icon

Screen for disc information

No.	Remarks	Changing method
1	To show the current title No. [DVD] or track No. [Video CD/CD] and to jump to the desired title No. or track No.*1	▲ ▼ or Numeric/SELECT
2	To show the current chapter No. or to jump to the desired chapter No. [DVD only]	▲ ▼ or Numeric/SELECT
3	To show the elapsed time and to directly select scenes by the elapsed time*2 [DVD] or to show the elapsed time [Video CD/CD]	Numeric/SELECT
4	To show the current audio soundtrack language No. and to change to the desired one [DVD only] (See page 29.)	▲ ▼ or Numeric
5	To show the audio soundtrack language selected using the above icon [DVD only]	—
6	To show the audio attribute (type) of the disc currently being played [DVD only] ●LPCM (Linear PCM), MPEG (MPEG audio) or  [Dolby Digital (AC-3)]	—
7	To show the audio attribute (sampling frequency or channel No.) of the disc currently being played [DVD only] ●For Linear PCM disc: 48 kHz or 96 kHz ●For Dolby Digital (AC-3) disc: 1ch to 5.1ch ●For MPEG audio disc: 1ch to 5ch	—
8	To show the audio attribute (bit No.) of the disc currently being played [DVD only] ●For Linear PCM disc: 16 bit to 24 bit	—
9	To show the number of recorded vocals [DVD Karaoke only] (See page 29.) ●1 vocal: ON or "—" (OFF) ●2 vocals: V1+V2, V1, V2 or "—" (OFF)	—
10	To show the current subtitles language No. and to change to the desired one [DVD only] (See page 28.)	▲ ▼ or Numeric
11	To show the subtitle language selected using the above icon [DVD only]	—
12	To display/clear subtitles [DVD only] (See page 28.)	▲ ▼
13	To show the current angle No. and to change to the desired one [DVD only] (See page 30.)	▲ ▼ or Numeric
14	To select the audio mode [Video CD only] (See page 29.) ●LR, L or R	▲ ▼
15	To show whether Video CD menu play is ON or OFF [Video CD with playback control only] (See pages 15, 16 and 19.)	—

●"▲ ▼" means tilting the joystick to the ▲/▼ direction and "Numeric" means the numeric button.

*1The track number cannot be selected during menu play of the Video CD.

*2Some discs may not work with some DVDs.

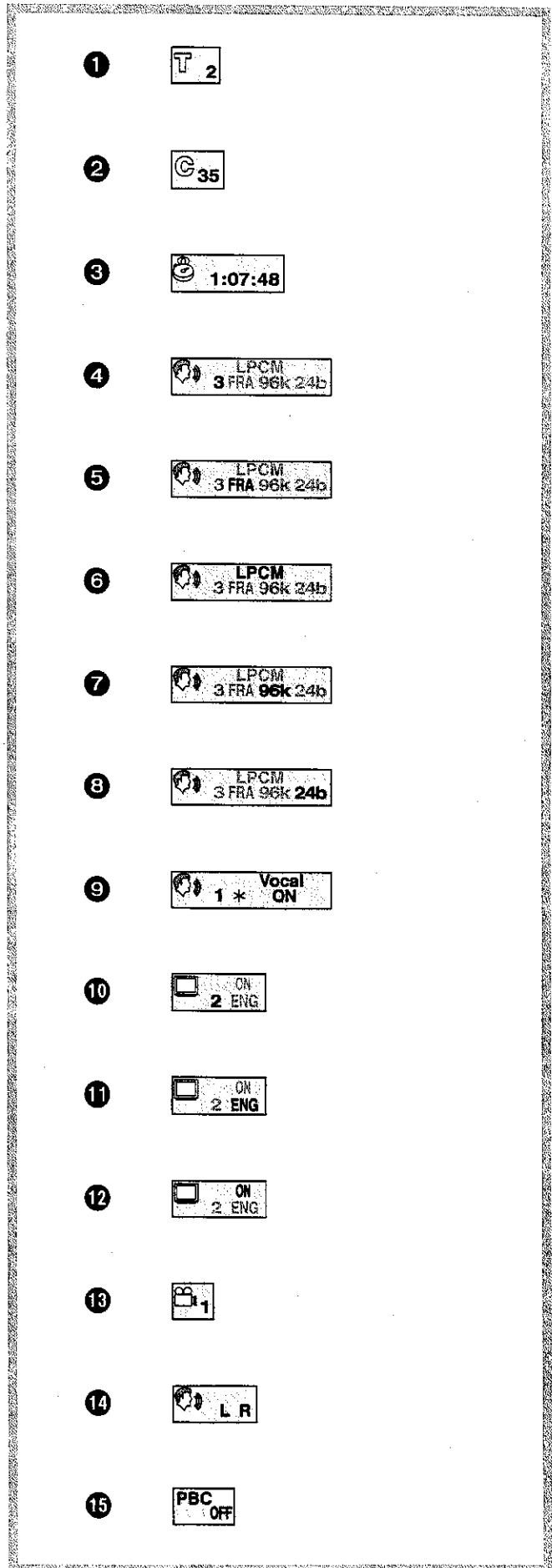

Detailed descriptions of each GUI icon

For your reference:

- For the language abbreviations used for the audio soundtrack and subtitle language icons, see the table **A**.

Screen for player information **B**

No.	Remarks	Changing method
1	To start A-B repeat play (See page 26.)	SELECT
2 ^{#1}	To select the repeat play mode (See page 25.) • C (chapter repeat), T (title repeat) or OFF (normal play) [DVD] • T (track repeat), A (disc repeat) or OFF (normal play) [Video CD/CD]	▲ ▼
3 ^{#1}	To show the current play mode [Video CD/CD only] (See pages 23 and 24.) • "----" (normal play), PRG (program play) or RND (random play)	—
4 ^{#1}	To store a marker	SELECT
	To recall a marker	◀▶▶▶▶▲
	To clear a marker	◀▶▶▶▶→CLEAR
(See page 27.)		
5	To select the picture mode [DVD/Video CD only] • N (normal), S (soft) or F (fine)	▲ ▼
6	To select the virtual surround sound mode [DVD only] (See page 30.) • OFF, 1 (natural effect) or 2 (emphasized effect)	▲ ▼
7	To adjust the master volume to be output from the audio output connectors of the player • 0 to -127 dB or -∞ (minimum)	▲ ▼

• "◀▶▶▶▶▲" means tilting the joystick to the ◀/▶/▲/▼ direction.

*^{#1}This function does not work with an interactive DVD or during menu play of Video CD.

Screen for slow-motion play and rapid advance (reverse) **C**

- Still/Pause**
Tilt the joystick to the ▲ direction to select "▶▶".
- Slow-motion play**
Tilt the joystick to the ◀/▶ direction.*
◀I: Backward [DVD only]
I▶: Forward [DVD/Video CD only]
- Play**
Tilt the joystick to the ▼ direction to select "▶".
- Rapid reverse/advance**
Tilt the joystick to the ◀ (Backward)/▶ (Forward) direction.*

*Each time the joystick is tilted, the speed increases in up to

A

ENG	English	FRA	French	DEU	German
ITA	Italian	ESP	Spanish	NLD	Dutch
SVE	Swedish	NOR	Norwegian	DAN	Danish
POR	Portuguese	RUS	Russian	JPN	Japanese
CHI	Chinese	KOR	Korean	MAL	Malay
VIE	Vietnamese	THA	Thai	*	Others

B

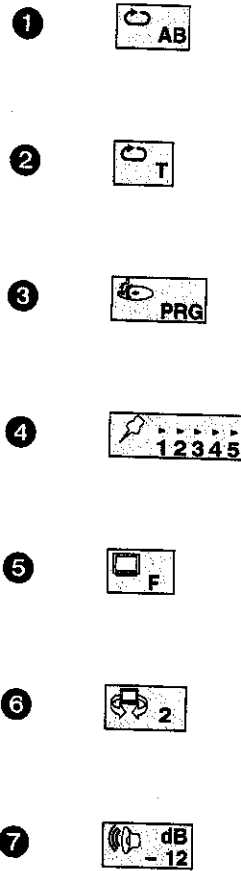

C

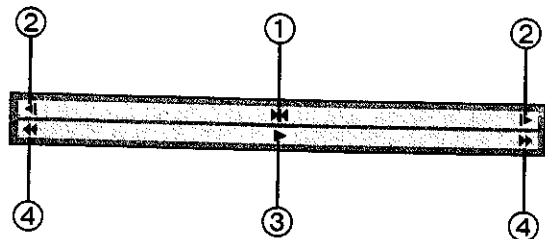

Program play [Video CD/CD]

The player plays the tracks in the disc in an order you specify.

1 Press PLAY MODE in the stop mode.

The program playback screen appears on the TV monitor.

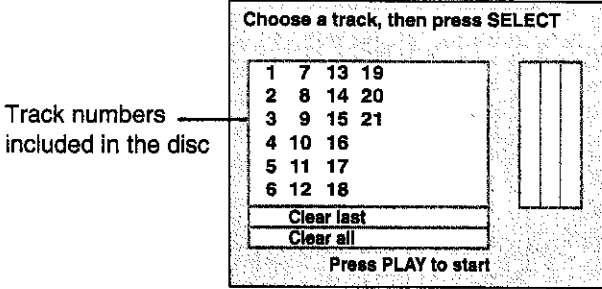

2 Tilt the joystick to the ◀/▶/▲/▼ direction and press SELECT, or press the numeric button(s), to select the preferred track number.

The selected track is stored in the memory.

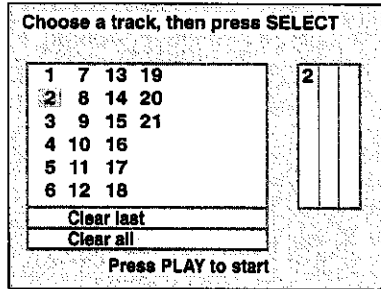

- Repeat step 2 to select another track.
- Up to 18 tracks can be programmed.

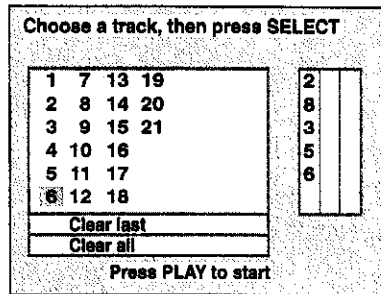

3 Press PLAY.

Play now begins in the programmed sequence.

After playback

Play is stopped and the program playback screen is displayed.

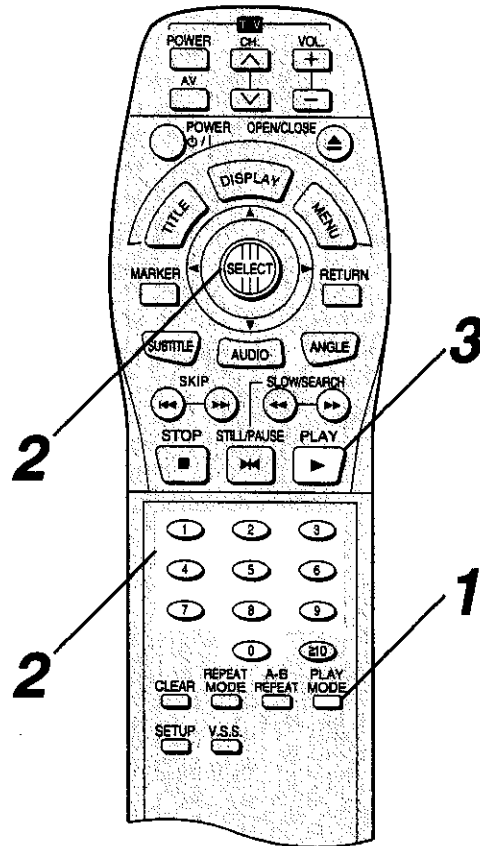

Program play [Video CD/CD]

Returning to normal play **A**

1. Press STOP. (Program play is suspended.)
2. Press PLAY MODE twice.
3. Press PLAY.
Normal play begins.
(The content of the program is still retained in the memory.)

Clearing the program **A**

When the program playback screen is displayed

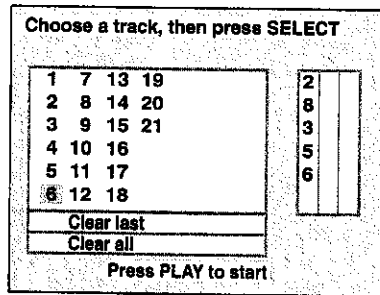

- **To clear the last program one by one**
Move to "Clear last" and press SELECT.
(Pressing CLEAR of the remote control unit also clears the last program.)
- **To clear all the programs**
Move to "Clear all" and press SELECT.
(The programs are also cleared when the power is switched to the standby mode or the disc is removed.)

Random play [Video CD/CD] **B**

The player plays the tracks in the disc in random order.

- 1 Press PLAY MODE twice in the stop mode.**
The random playback screen appears on the TV monitor.

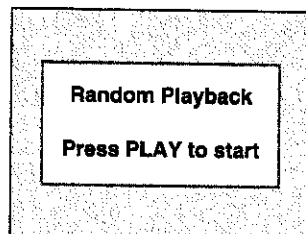

- 2 Press PLAY.**

Play now begins in the random order.

After playback

Play is stopped and the random playback screen is displayed.

Returning to normal play

1. Press STOP. (Random play is suspended.)
2. Press PLAY MODE.
3. Press PLAY.
Normal play begins.

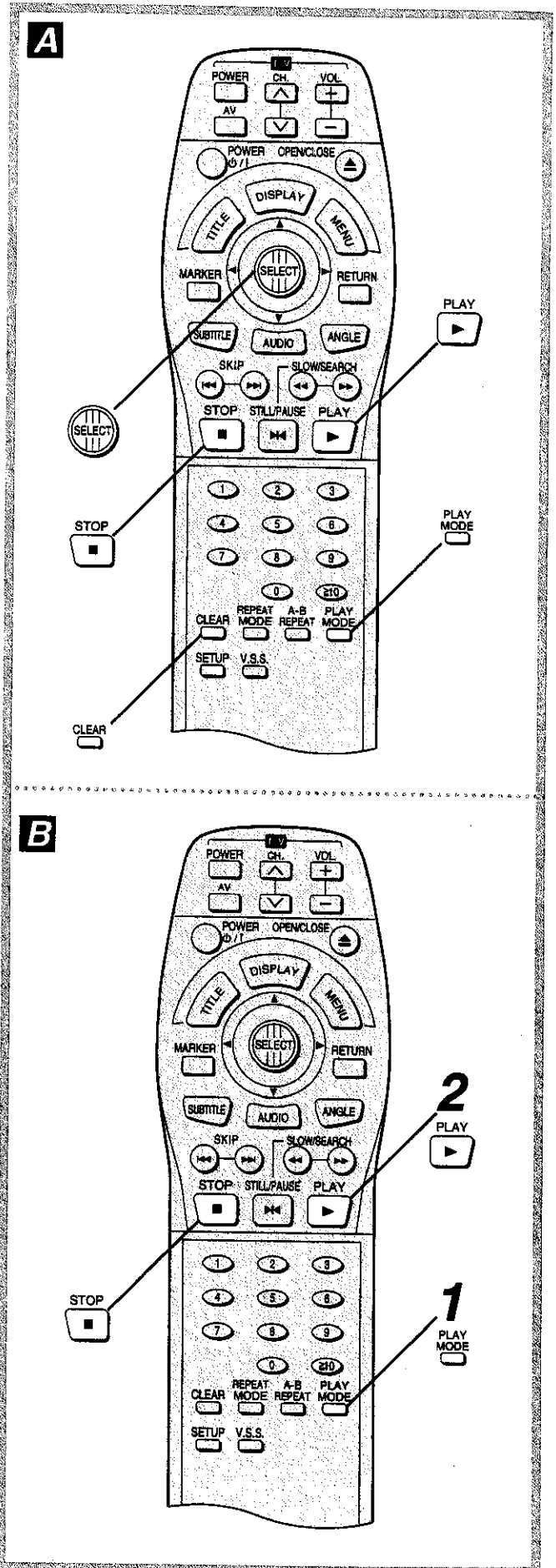

Repeat play

Repeat viewing (listening)

Press **REPEAT MODE** during play.

Each time this button is pressed, the TV monitor changes as shown below and the disc will repeat a chapter or title (DVD) or a track (Video CD/CD).

•DVD

Repeat of chapter being played

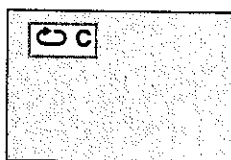

Repeat of title being played

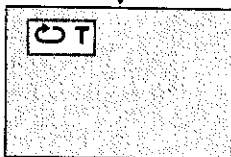

Cancel repeat mode
(Normal play)

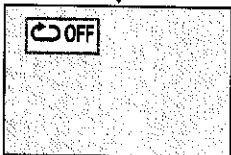

•Video CD/CD

Repeat of track being played

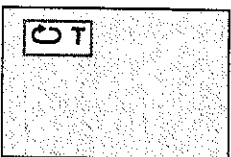

Repeat of entire disc contents

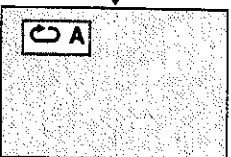

Cancel repeat mode
(Normal play)

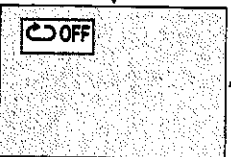

To return to normal play

Press **REPEAT MODE** several times until "OFF" is displayed.

Note:

- Repeat play works only with discs for which the elapsed playing time appears on the unit's display during playback.
- Repeat play may not work correctly with some DVDs.

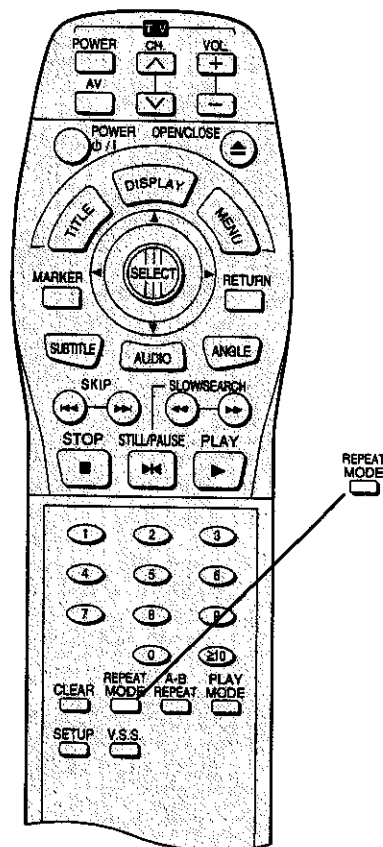

Repeat play

To enjoy program repeat play

If REPEAT MODE is pressed during program play (see pages 23 and 24), the display changes as follows:

Repeat of programmed track being played



Repeat of all programs

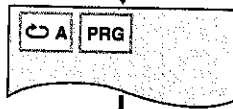

Cancel repeat mode
(Normal program play)



Repeating sections between two specific points (A-B repeat)

- 1 Press A-B REPEAT during play at the point where repeat play is to commence (A).

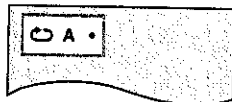

- 2 Press A-B REPEAT at the point where repeat play is to be concluded (B).

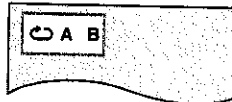

Repeat play of the selection between points A and B starts.

To return to normal play

Press A-B REPEAT several times until "A ." is displayed.

Note:

- A-B repeat play works only within a title [DVD] or a track [Video CD/CD].
- A-B repeat play works only with discs for which the elapsed playing time appears on the unit's display during playback.
- Some subtitles recorded around point A or B may fail to appear. [DVD]

A

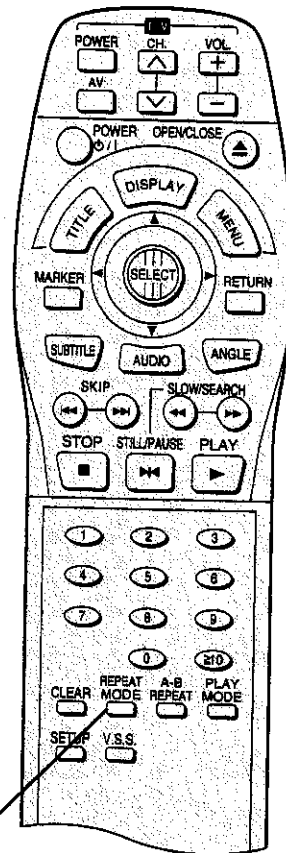

REPEAT MODE

B

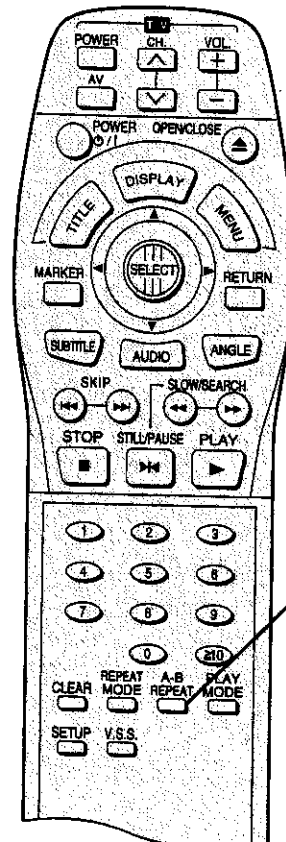

1
2
A-B REPEAT

Storing markers in memory to be viewed (listened) again

Storing a marker in the memory

1 Press MARKER during play.

"." indicates no marker has been stored yet.

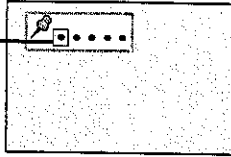

2 Press SELECT during play at the starting point to be viewed (listened) again.

Indicates "MARKER 1" is stored in the memory.

(If SELECT is pressed where any number is already displayed, the previous starting point will be replaced by the new one.)

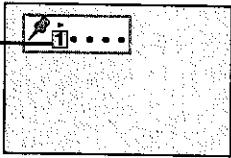

Up to 5 markers can be stored in the memory.

- Press MARKER to clear the display.

Recalling/clearing a marker

1 Press MARKER during play.

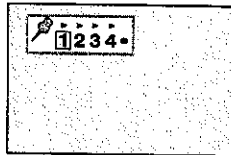

2 Tilt the joystick to the ◀/▶ direction to select the marker to be recalled/cleared.

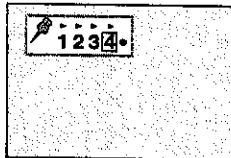

3 Tilt the joystick to the ▲ direction to recall a marker.

or

Press CLEAR to clear a marker.

Play resumes from the point corresponding to the selected marker. (The display will be cleared automatically.)

or

The selected marker is cleared. (Press MARKER to clear the display.)

Note:

- These operations work only with discs for which the elapsed playing time appears on the unit's display during playback.
- Some subtitles recorded around the marker may fail to appear. [DVD]

For your reference:

- All the markers are cleared when the power is switched to standby mode or the disc is removed.

A

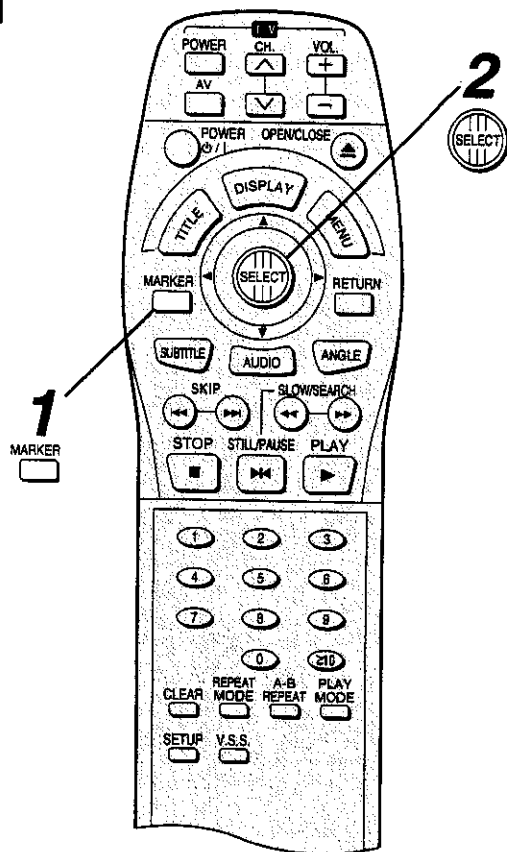

B

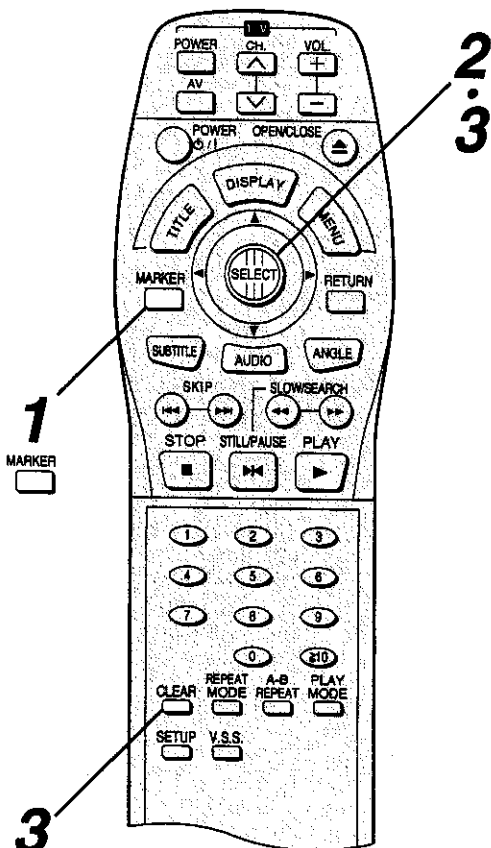

Changing subtitle language

[DVD only]

It is possible to change the subtitle language from the one selected at the initial settings to a different language, if available. (See page 33.)

(This operation works only with discs on which multiple subtitle languages are recorded.)

1 Press SUBTITLE during play.

- When no subtitles are recorded “—” will be displayed instead of the language number.

Number of the subtitle language being played back

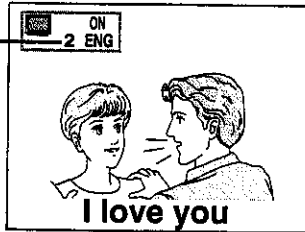

2 Tilt the joystick to the ▲/▼ direction until the preferred language is selected.

Pressing the numeric button(s) also changes the subtitle language.



- Press SUBTITLE or SELECT to clear the display.

To clear/display the subtitles

Tilt the joystick to the ◀/▶ direction to select ON or OFF at the step 2.

Note:

- In some cases, the subtitle language is not changed immediately to the selected one.

For your reference:

- When the preferred language is not selected even after tilting the joystick several times, it means that the language is not available on the disc.
- When the power is turned on or the disc is removed, subtitles appear in the language selected at the initial settings. If this language is not recorded on the disc, they appear in the disc's priority language.

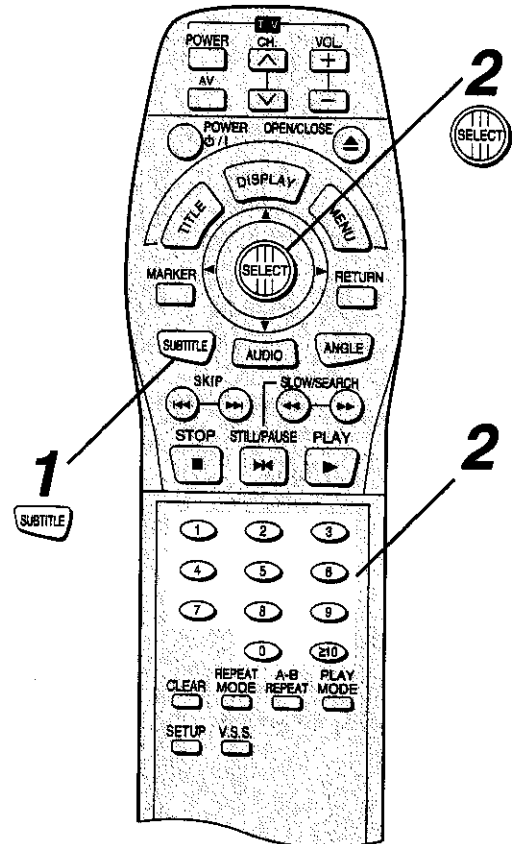

Changing audio soundtrack language [DVD only]

It is possible to change the audio soundtrack language from the one selected at the initial settings to a different language, if available. (See page 33.)

(This operation works only with discs on which multiple audio soundtrack languages are recorded.)

1 Press AUDIO during play.

- When no audio soundtrack is recorded, “-” will be displayed instead of the language number.

Number of the audio soundtrack language being played back

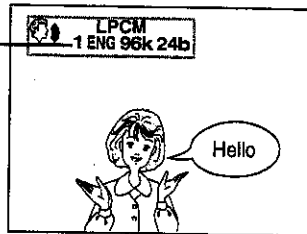

2 Tilt the joystick to the ▲/▼ direction until the preferred language is selected.

Pressing the numeric button(s) also changes the audio soundtrack language.



- Press AUDIO or SELECT to clear the display.

For your reference:

- When the preferred language is not selected even after tilting the joystick several times, it means that language is not available on the disc.
- When the power is turned on or the disc is removed, the language heard is the one selected at the initial settings. If this language is not recorded on the disc, only the available language on the disc will be heard.

Switching vocals ON or OFF for Karaoke discs [DVD/Video CD]

1 Press AUDIO during play.

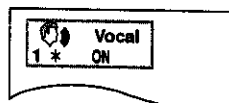

2 Tilt the joystick to the ◀/▶ direction until the preferred setting is selected.

- DVD Karaoke (1 vocal)

ON ← → --- (OFF)



- DVD Karaoke (2 vocals)

1+2 → V1 → V2 → --- (OFF)

- Video CD

LR → L → R



- Press AUDIO or SELECT to clear the display.

Note:

Operation does not work with CDs.

A

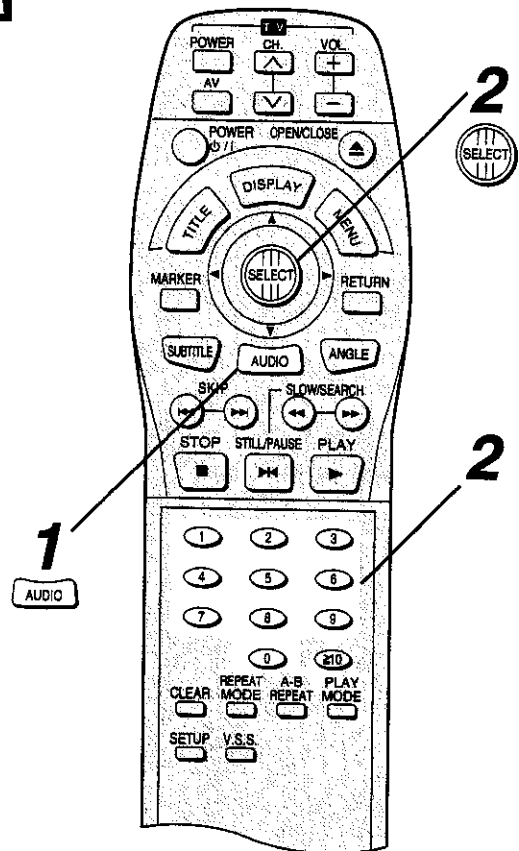

B

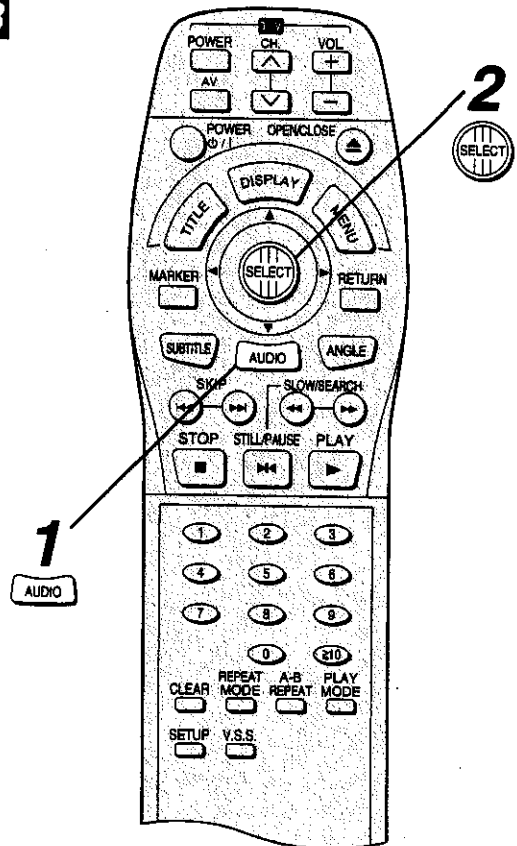

Viewing from another angle

[DVD only] **A**

Some DVDs may contain scenes which have been shot simultaneously from a number of different angles. For these discs, the same scene can be viewed from each of these different angles using the ANGLE button. (The recorded angles differ depending on the disc used.)

1 Press ANGLE during play.

Number of angle being played back

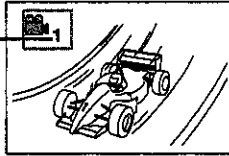

2 Tilt the joystick to the ▲/▼ direction until the preferred angle is selected.

Pressing the numeric button(s) also changes the angle.

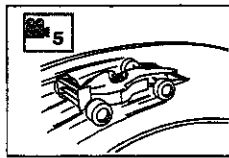

• Press ANGLE or SELECT to clear the display.

Note:

- This function only works for discs having scenes recorded at different angles.
 - The ANGLE indicator on the unit lights up at scenes recorded at different angles to indicate that angle switching is possible.
- The angle number can be programmed beforehand; the angle will be switched to the selected number when the ANGLE indicator lights up.

Reproducing a virtual surround effect

[Dolby Digital (AC-3) 5.1ch DVD only] **B**

This unit can reproduce a virtual surround effect which reproduces a sound as if heard from nonexistent rear speakers at the side even when only a 2-channel stereo system is connected [for playback of Dolby Digital (AC-3) 5.1ch DVD only].

Press V.S.S. on the remote control or VIRTUAL SURROUND SOUND on the unit during play.

Each time this button is pressed, the unit's display changes as shown below **C**:

- 1 Virtual surround 1 (Natural effect)
- 2 Virtual surround 2 (Emphasized effect)
- 3 Virtual surround is cancelled

Notes:

- The virtual surround effect may not work properly for some DVD software.
- Turn off the TV surround sound and other surround effects when using this virtual surround effect.

For your reference:

- The VIRTUAL SURROUND SOUND indicator on the unit lights up in green when the Dolby Digital (AC-3) 5.1ch DVD is played back with the virtual surround effect.
- For optimum effect, it is recommended that the distance between the TV set and the listening position be about 3 or 4 times the distance between the right and left front speakers.

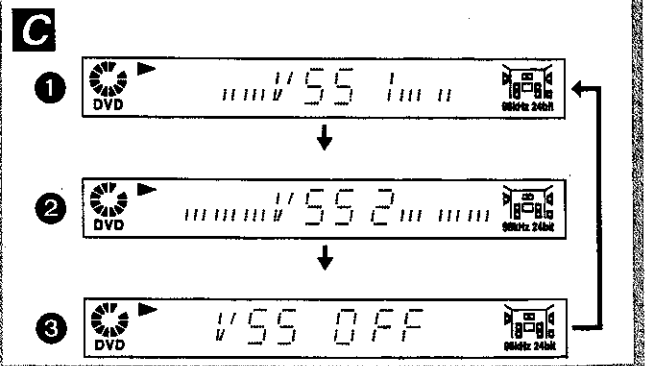
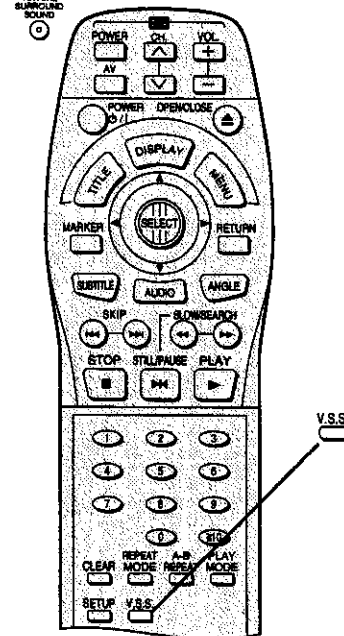
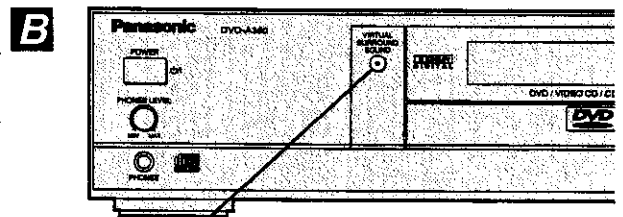
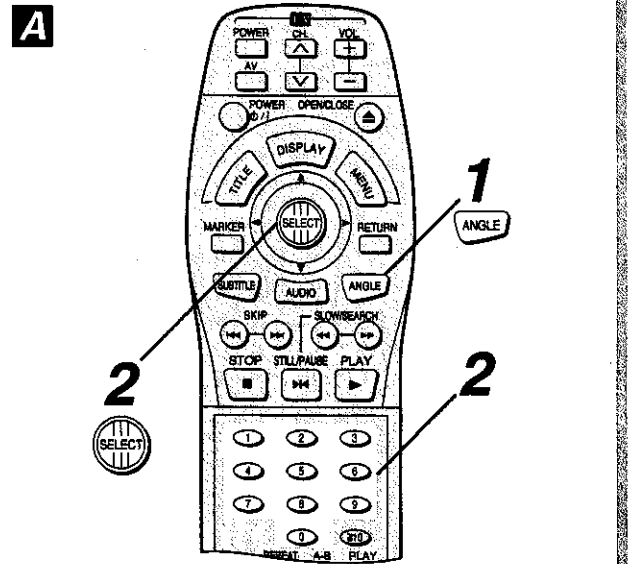

Using a title menu [DVD only] **A**

Some discs with movies, for example, may be available with two or more titles. If the disc has a title menu recorded on it, the TITLE button can be used to select the movie title.

(The details of operation differ depending on the disc used.)

1 Press TITLE during play.

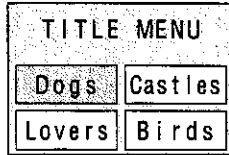

A list of the titles on the disc is now displayed.

(Example)

• Pressing TITLE again resumes play from the scene when TITLE was first pressed.

2 Tilt the joystick to the ◀/▶/▲/▼ direction and press SELECT or PLAY, or press the numeric button(s), to select the preferred title.

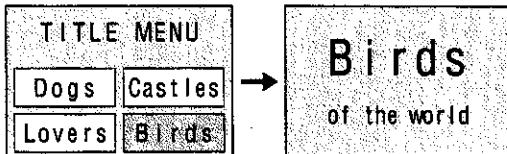

The selected title now starts playing.

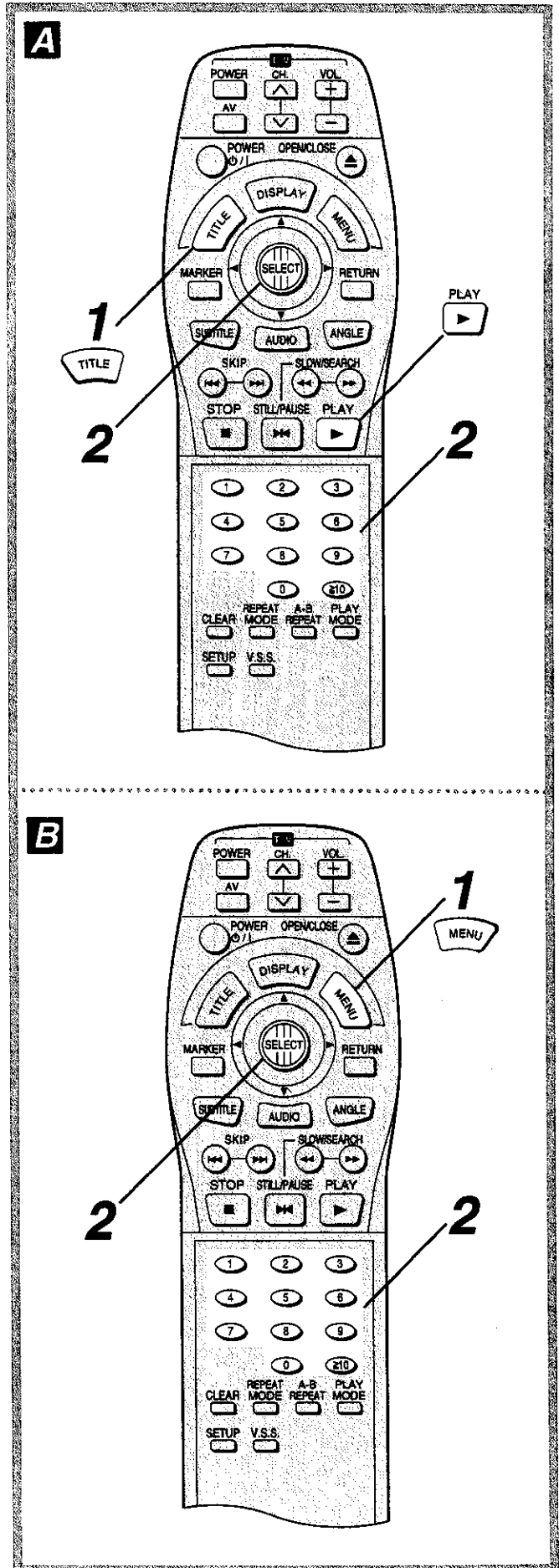

Using a DVD menu [DVD only] **B**

Some DVDs have unique menu structures called DVD menus. For example, DVDs programmed with complex contents provide guide menus, and those recorded with various languages provide menus for audio and subtitle language. Although the DVD menu's contents and operation differ from disc to disc, the following explains basic operation when this feature is used.

1 Press MENU during play.

The DVD menu available on the disc is now displayed.

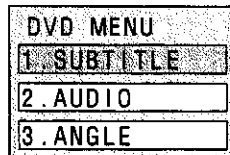

(Example)

• Pressing MENU again resumes play from the scene when MENU was first pressed.

2 Tilt the joystick to the ◀/▶/▲/▼ direction and press SELECT, or press the numeric button(s), to select the preferred item.

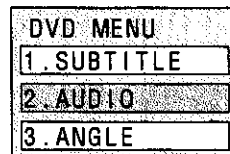

The selected item is now executed.

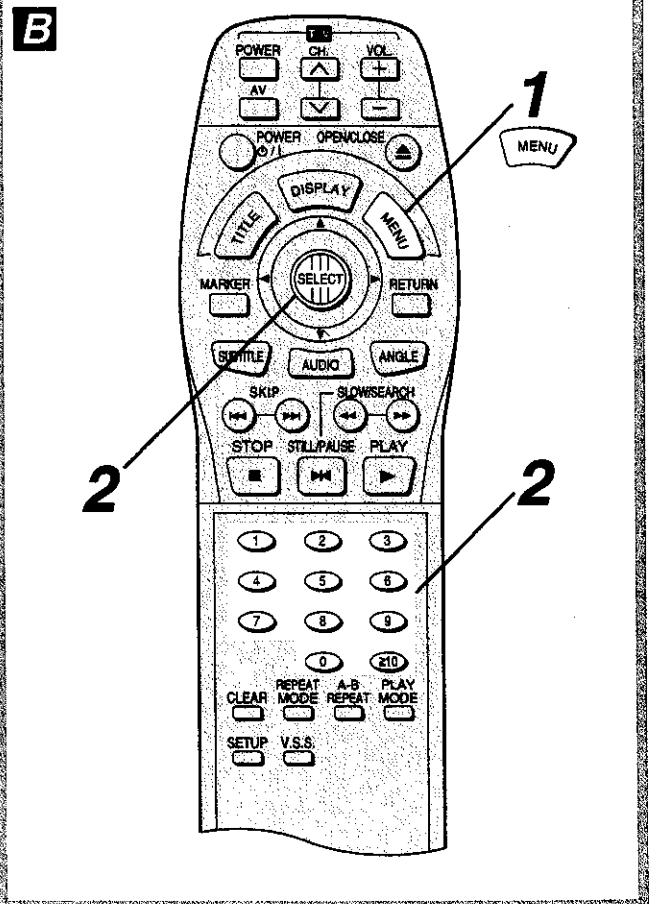

When the menu continues onto another screen
Repeat step 2.

Initial settings

Once the initial settings have been completed, the player can always be operated under the same conditions (especially with DVD discs).

The settings will be retained in the memory even after switching the power to the standby mode until the settings are changed.

Common procedures of initial settings

1 Press SETUP in the stop mode.

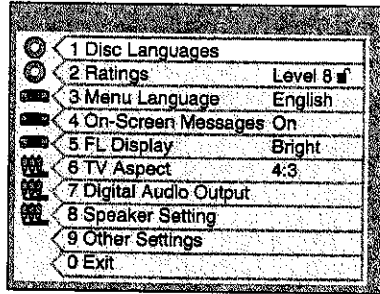

2 Tilt the joystick to the ▲/▼ direction to select the preferred item and SELECT.

Each screen for setting the value is displayed.

- 1 Disc Languages (see page 33)
- 2 Ratings (see page 34)
- 3 Menu Language (see page 35)
- 4 On-Screen Messages (see page 36)
- 5 FL Display (see page 36)
- 6 TV Aspect (see page 37)
- 7 Digital Audio Output (see page 38)
- 8 Speaker Setting (see page 39)
- 9 Other Settings (see page 41)

3 Tilt the joystick to the ▲/▼ direction to select the preferred value and press SELECT.

•Some items require additional steps. (See the respective page.)

Setting is finished and the initial settings screen is displayed.

To cancel during setup operation

Press RETURN or select "0". (The previous screen is displayed.)

To clear the initial settings screen

Tilt the joystick to the ▲/▼ direction to select "0" and press SELECT. (Pressing SETUP or RETURN also clears the initial settings screen.)

For your reference:

•The numeric buttons can also be used for selecting items or values instead of the joystick; in this case, pressing SELECT is not necessary.

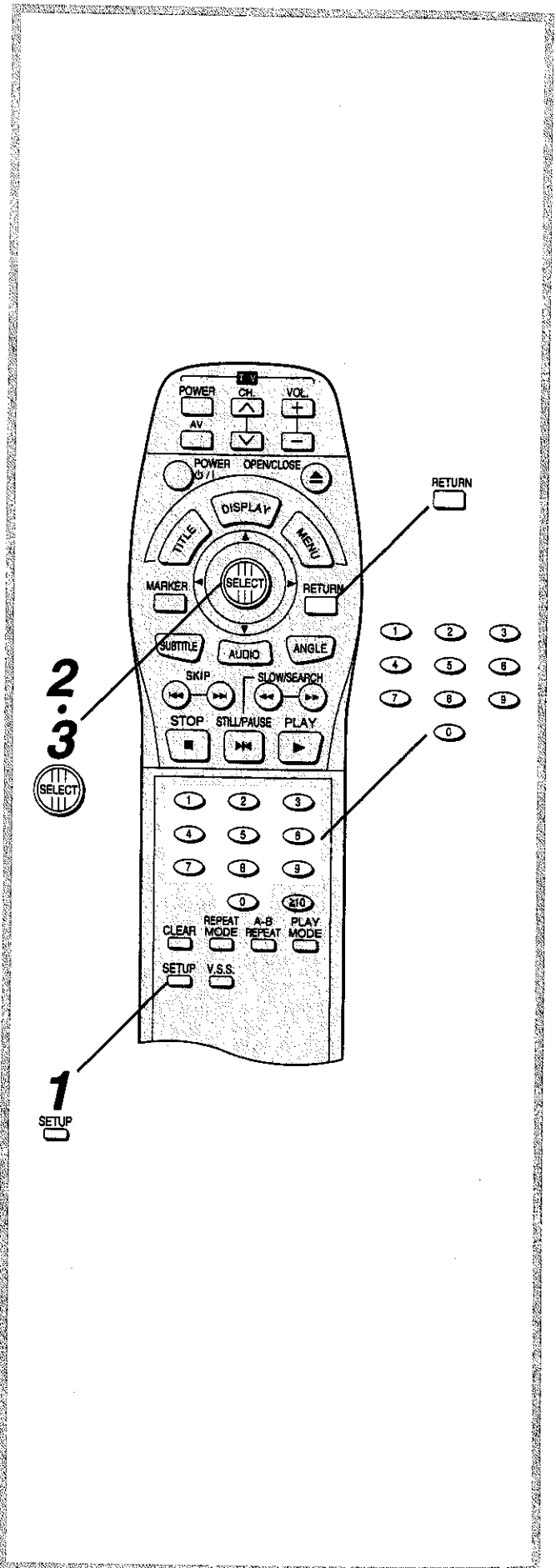

Initial settings

Selecting disc languages [DVD only]

This is to select the audio soundtrack language, subtitle language and the language used in title menus or DVD menus which will always be used for every disc to be played back.

- 1 At the initial settings screen
Select "1 Disc Languages" by the joystick and press SELECT.

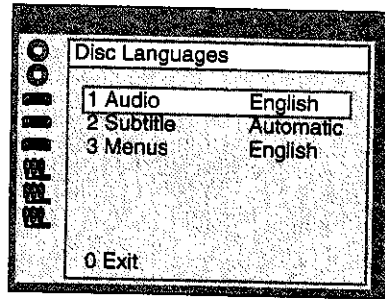

- 2 Select the preferred item (1-3) by the joystick and press SELECT.

When "1 Audio" is selected

English: English is selected (Factory setting)

French/German/Italian/Spanish:

Each language is selected.

Original: The original language of each disc will be selected.

Other **:** Another language can be selected. (Refer to the language codes on page 47. Press CLEAR if an incorrect language code is entered.)

When "2 Subtitle" is selected

Automatic: The same language selected for the "Audio" will be selected. (Factory setting)

- if the language selected for the "Audio" is actually used during playback, the subtitles will not appear.

- if another language is used during playback, the subtitles will appear in the language selected at the setup "Audio".

English/French/German/Italian/Spanish:

Each language is selected.

Other **:** Another language can be selected.

When "3 Menu" is selected

English: English is selected (Factory setting)

French/German/Italian/Spanish:

Each language is selected.

Other **:** Another language can be selected.

- 3 Select the preferred language by the joystick at each screen and press SELECT.

The screen at the step 1 is displayed. Select "0" by the joystick and press SELECT to return to the initial settings screen.

Note:

- if the language selected is not available on the disc, the language designated by each disc will be selected.

Also refer to "Common procedures of initial settings" on page 32.

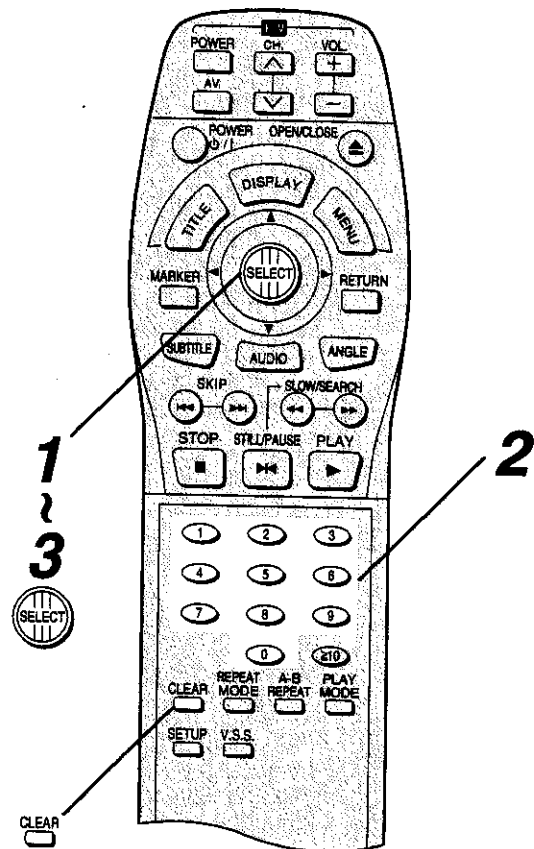

Initial settings

Selecting rating level [DVD only]

This is to disable the playing of specified DVDs which are unsuitable for children.

- Some DVDs are encoded with specific rating level. If the rating level of the disc is higher than that preset in the setup operation, playback of the disc will be prohibited.

- At the initial settings screen
Select "2 Ratings" by the joystick and press SELECT.

All DVDs can be played back. (Factory setting)

DVDs for general audiences/children can be played back. (DVDs for adults are prohibited.)

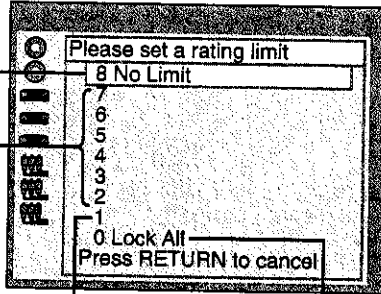

DVDs for children can be played back. (DVDs for adults/general audiences are prohibited.)

Playback of all DVDs is prohibited. (e.g. to prohibit playback of DVDs for adults which are not encoded with rating level information)

- Select the preferred level by the joystick and press SELECT.

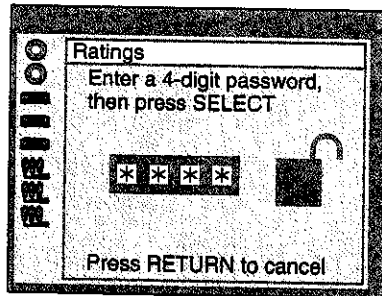

- When level 7 or lower is selected
Input a 4-digit password and press SELECT.

The lock symbol appears closed to show the rating is locked.

Example: "4343"
Do not forget your password.



- Press SELECT.

Setting is finished and the initial settings screen is displayed.

- The rating is locked. Any discs whose rating is higher than the setting cannot be played back unless the correct password is entered.

Also refer to "Common procedures of initial settings" on page 32.

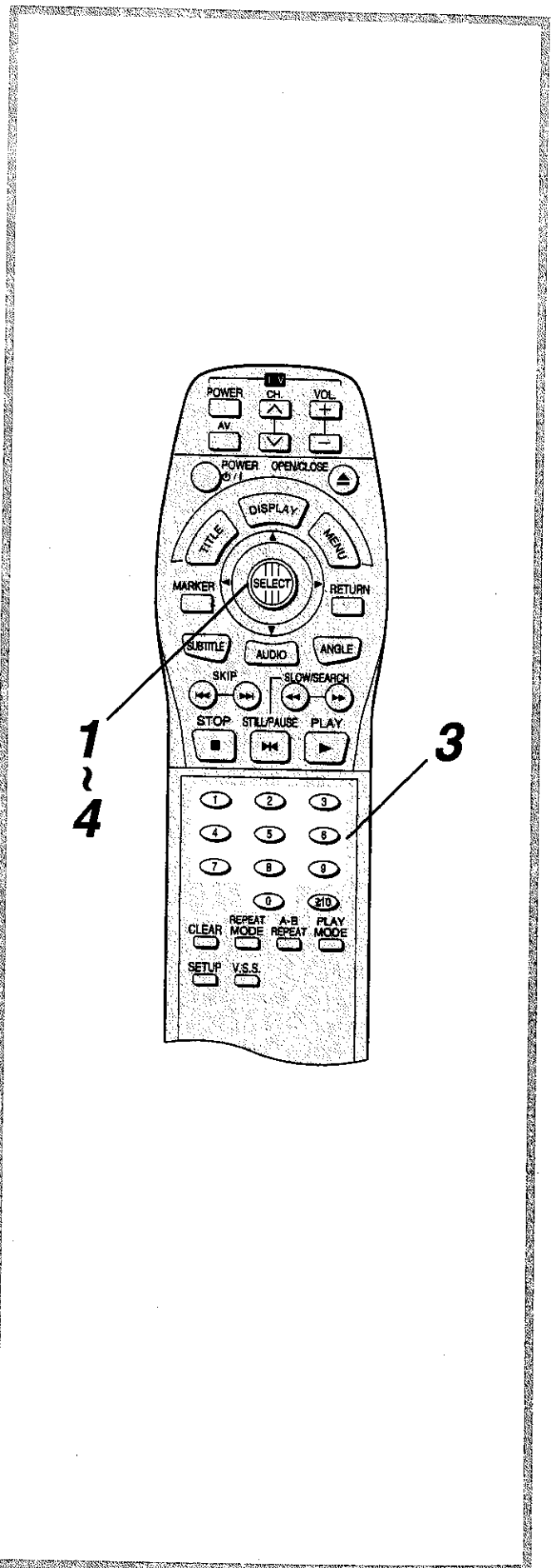

Initial settings

To change the settings

1. Select "2" by the joystick at the initial settings screen and press SELECT.

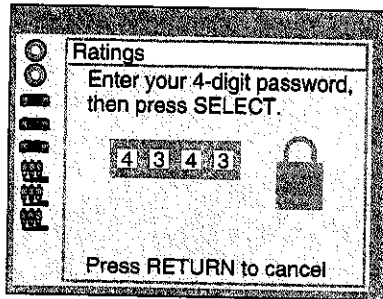

2. Input a 4-digit password and press SELECT.

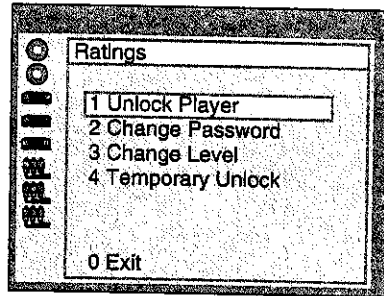

3. Select the preferred item (1-4) by the joystick and press SELECT.
4. **1 Unlock Player**
Press SELECT.
4. **2 Change Password**
Enter a new 4-digit password and press SELECT. Press SELECT again.
4. **3 Change Level**
Select a level and press SELECT.
4. **4 Temporary Unlock**
(The rating is unlocked temporarily only for the current disc.)
Press SELECT.
5. Select "0" and press SELECT to exit.

Setting is finished and the initial settings screen is displayed.

Note:

- Some discs may not be encoded with specific rating level information though its disc jacket says that it is for "adults". For those discs, the age restriction will not work.

Selecting language of On-Screen Display menu

- 1 At the initial settings screen
Select "3 Menu Language" by the joystick and press SELECT.

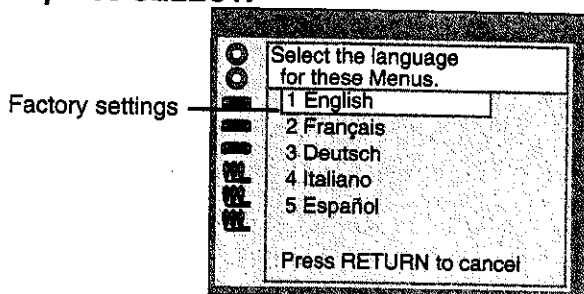

- 2 Select the preferred language (1-5) by the joystick and press SELECT.

Setting is finished and the initial settings screen is displayed.

Also refer to "Common procedures of initial settings" on

A

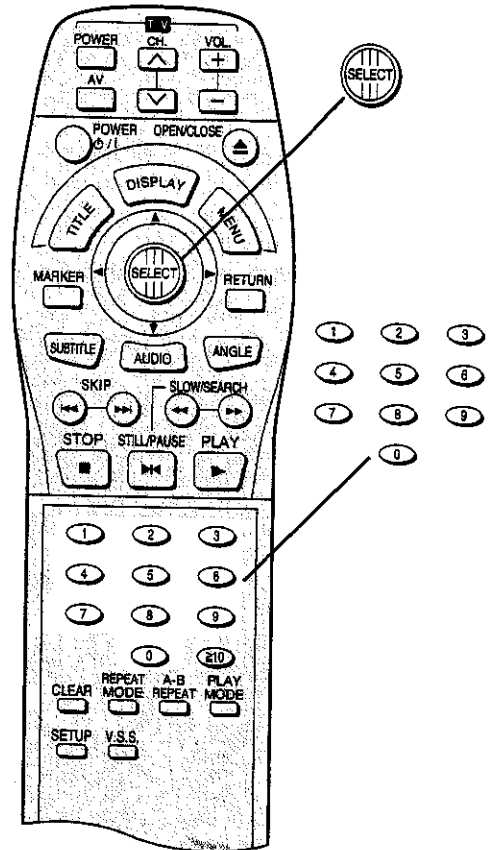

B

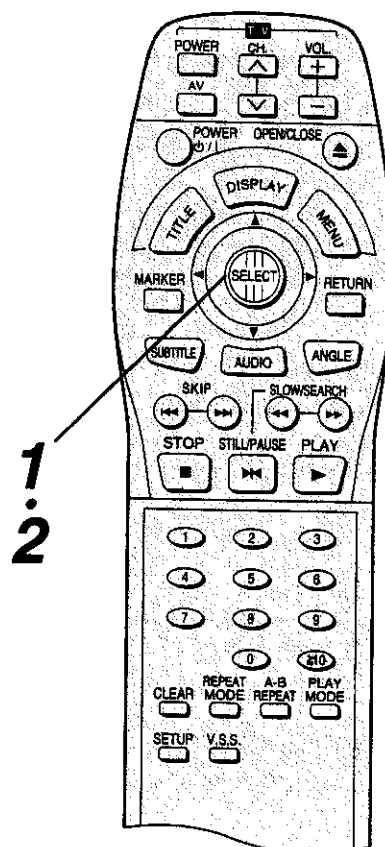

Initial settings

Switching the On-Screen Display ON or OFF **A**

You can select whether On-Screen Display messages such as PLAY and STOP will be displayed or not.

- 1 At the initial settings screen
Select "4 On-Screen Messages" by the joystick and press SELECT.

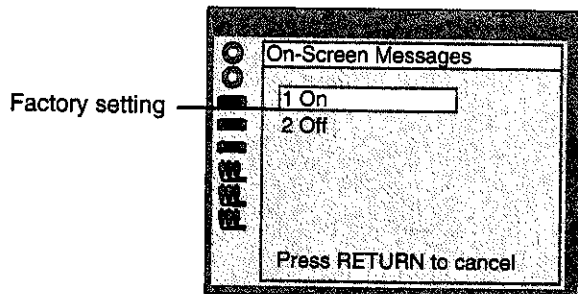

- 2 Select the preferred item (1 or 2) by the joystick and press SELECT.

Setting is finished and the initial settings screen is displayed.

Selecting the display brightness **B**

- 1 At the initial settings screen
Select "5 FL Display" by the joystick and press SELECT.

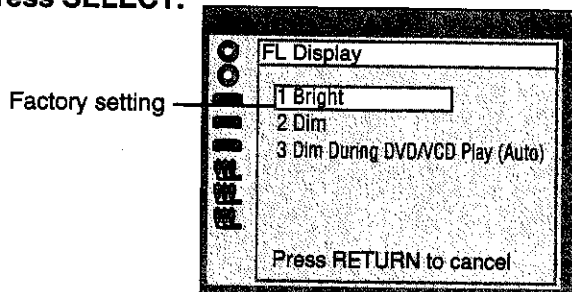

- 2 Select the preferred item (1-3) by the joystick and press SELECT.

Setting is finished and the initial settings screen is displayed.

For your reference:

- Even if "3 Dim During DVD/VCD Play (Auto)" is selected, the display resumes brightness when a button for special play such as SLOW/SEARCH and STILL/PAUSE is pressed.

Also refer to "Common procedures of initial settings" on page 32.

A

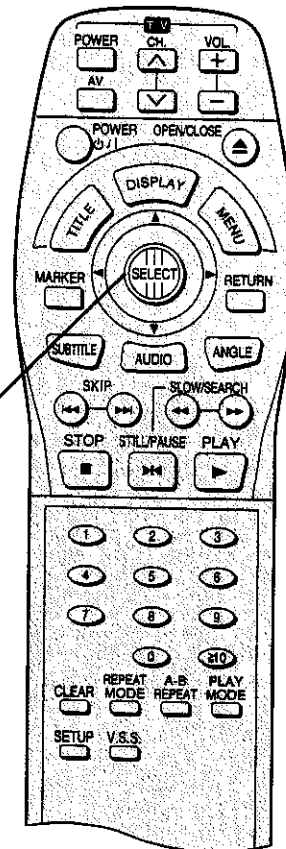

B

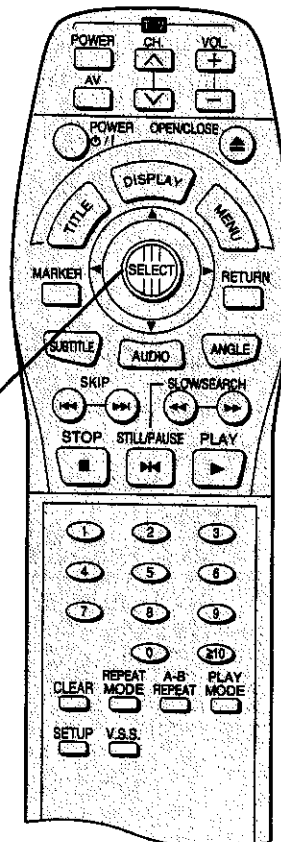

Initial settings

Selecting TV screen type

Select the appropriate screen type according to your TV set; conventional size screen (4:3) or wide-screen (16:9).

- 1 At the initial settings screen
Select "6 TV Aspect" by the joystick and press SELECT.

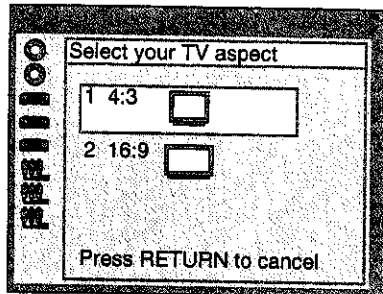

- 2 Select the preferred item (1 or 2) by the joystick and press SELECT.

4:3 Select when a conventional TV set is connected. (factory setting)

The video material formatted in the Pan & Scan style is played back in that style (the left and right edges are cut off).

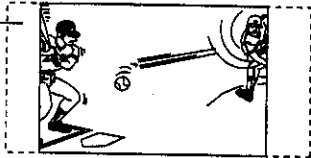

The video material not formatted in the Pan & Scan style is played back in the letterbox style (black bands appear at top and bottom of screen).



16:9 Select when a wide-screen TV set is connected.

Played in "FULL" size. (Setting the wide-screen TV to "FULL" mode is also necessary.)

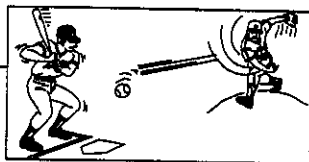

- * Each screen shows an example when the video material for a wide-screen is played. (This setting does not affect the video material for conventional size.)

Setting is finished and the initial settings screen is displayed.

Also refer to "Common procedures of initial settings" on page 32.

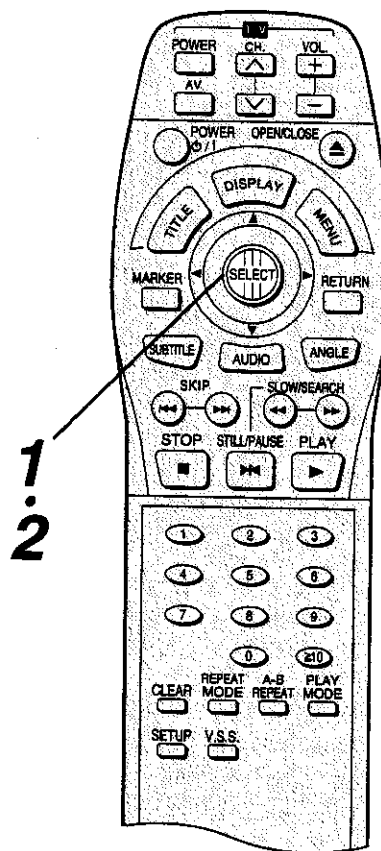

Initial settings

Selecting digital output

Select the digital output to be output from the optical/coaxial digital audio output connector of the unit.

- At the initial settings screen
Select "7 Digital Audio Output" by the joystick and press SELECT.

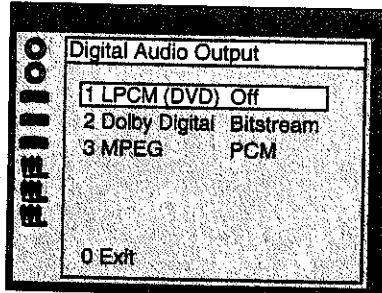

- Select the preferred item (1-3) by the joystick and press SELECT.

When "1 LPCM (DVD)" is selected

Off: Only linear PCM of 48 kHz/16 bit is output from the digital audio output connector. During playback of the DVD recorded in the linear PCM of 48 kHz/20 bit/24 bit or 96 kHz, no digital audio is output. (Factory setting)

PCM: During playback of the DVD recorded in the linear PCM of 48 kHz/20 bit/24 bit or 96 kHz, digital audio converted to 48 kHz/16 bit is output.

(Digital output of PCM audio is restricted to 48 kHz/16 bit or below for copyright protection.)

When "2 Dolby Digital" is selected

Bitstream: Dolby Digital (AC-3) bitstream (2ch-5.1ch) is output. (Factory setting)

PCM: PCM (2ch) of 48 kHz/16 bit is output.

When "3 MPEG" is selected

PCM: PCM of 16 bit is output. (Factory setting)

Bitstream: Bitstream is output.

- Select the preferred value by the joystick at each screen and press SELECT.

The screen at the step 1 is displayed. Select "0" by the joystick and press SELECT to return to the initial settings screen.

For your reference:

- Make settings as shown in the table below depending on the kind of amplifier that is connected to the optical/coaxial digital audio output connector.

Type of amplifier to be connected.	Recommendable setting		
	1 LPCM (DVD)	2 Dolby Digital	3 MPEG
No amplifier is connected	Off	Bitstream	PCM
AV amplifier including Dolby Digital decoder	PCM*	Bitstream	PCM
AV amplifier including MPEG audio and Dolby Digital decoder	PCM*	Bitstream	Bitstream

*Audio output from the unit's audio output connectors is converted to 48 kHz/16 bit in addition to audio from the digital audio output connector. To enjoy high quality sound at 48 kHz/20 bit/24 bit or 96 kHz, connect the amplifier or decoder directly to the audio output connectors, not to the digital audio output connector.

[Select "Off" at the "1 LPCM (DVD)"]

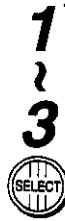
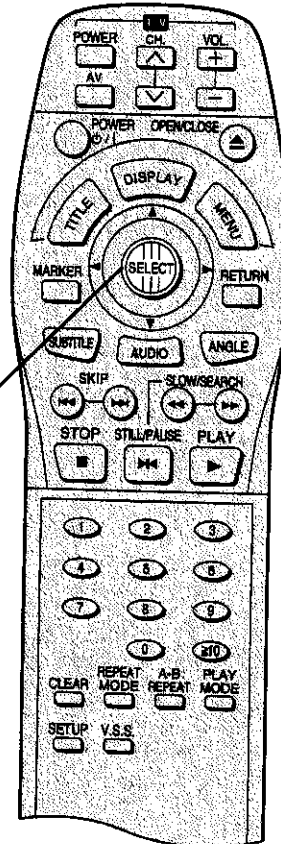

Also refer to "Common procedures of initial settings" on page 32.

Initial settings

Speaker setting

- At the Initial settings screen
Select "8 Speaker Setting" by the joystick and press SELECT.

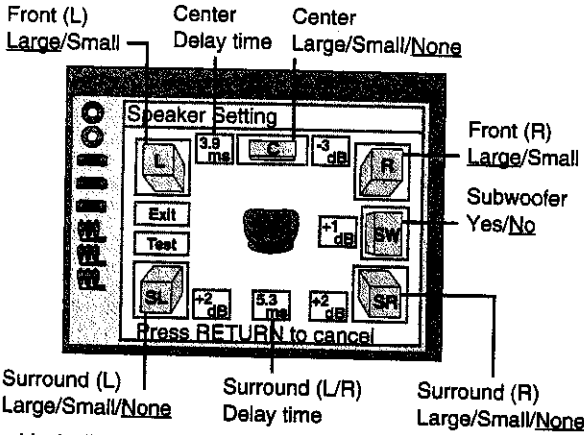

• Underlined item is a factory setting.



- Select the preferred item by the joystick and press SELECT.
- Select the preferred value by the joystick and press SELECT.

Speaker icons

- If the speaker is connected, display the icon. Clear the icon if the speaker is not connected.
- If the speaker supports low-frequency (under 100 Hz) reproduction, select the larger icon. If the speaker's low-frequency (under 100 Hz) reproduction ability is poor, select the smaller icon. [When the subwoofer is not connected, be sure to select "Large" for the front speakers (L/R).]

Delay time:

If the surround speakers or the center speaker can't be installed at an equal distance to (or further away) the front speakers from the listening position, change the delay time to get better surround effect.

- When D2 or D3 is equal to or larger than D1, no setting is necessary . Otherwise, change the setting according to the table below .

Speaker	Delay time	Difference between D1 and D2/D3
Center speaker (D2)	1.3 ms	approx. 50 cm
	2.6 ms	approx. 100 cm
	3.9 ms	approx. 150 cm
	5.3 ms	approx. 200 cm
Surround speakers (D3)	5.3 ms	approx. 200 cm
	10.6 ms	approx. 400 cm
	15.9 ms	approx. 600 cm

Channel balance:

While listening to the test signal, adjust the volume of the center, surround (L), surround (R) speakers and the subwoofer so that the volume is equal to that of the front speakers.

A

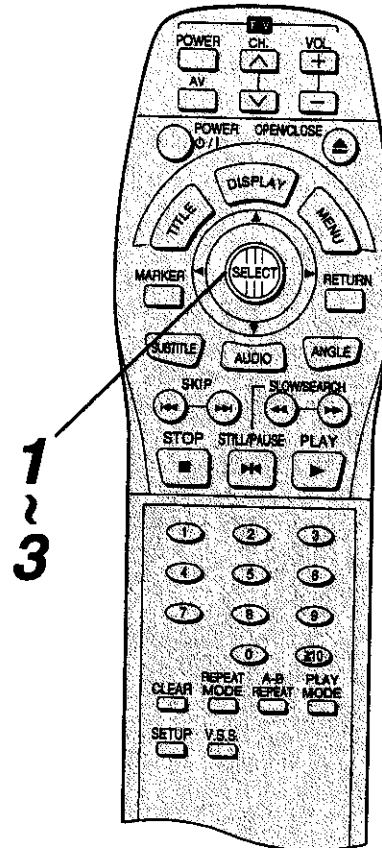

B

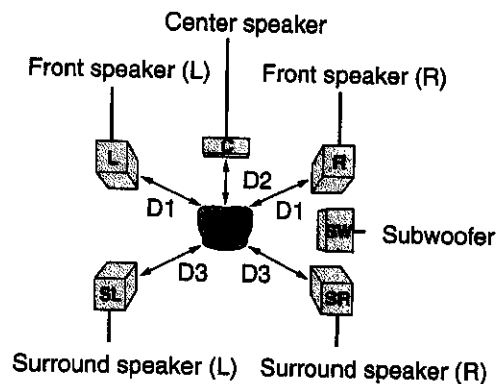

Initial settings

4 Select "Exit" by the joystick and press SELECT.

Setting is finished and the initial settings screen is displayed.

Note:

- The "Large/Small" setting has no effect on DVDs recorded in MPEG 2 audio.

For your reference:

•To output the test signal

1. Select "Test" by the joystick, and then press SELECT. (Test signals will be output consecutively from each speaker clockwise.)
2. Select the appropriate volume (−6 dB through +6 dB) by the joystick while the test signal is being output from the speaker.
3. Press SELECT. (The test signals are stopped.)

Also refer to "Common procedures of initial settings" on page 32.

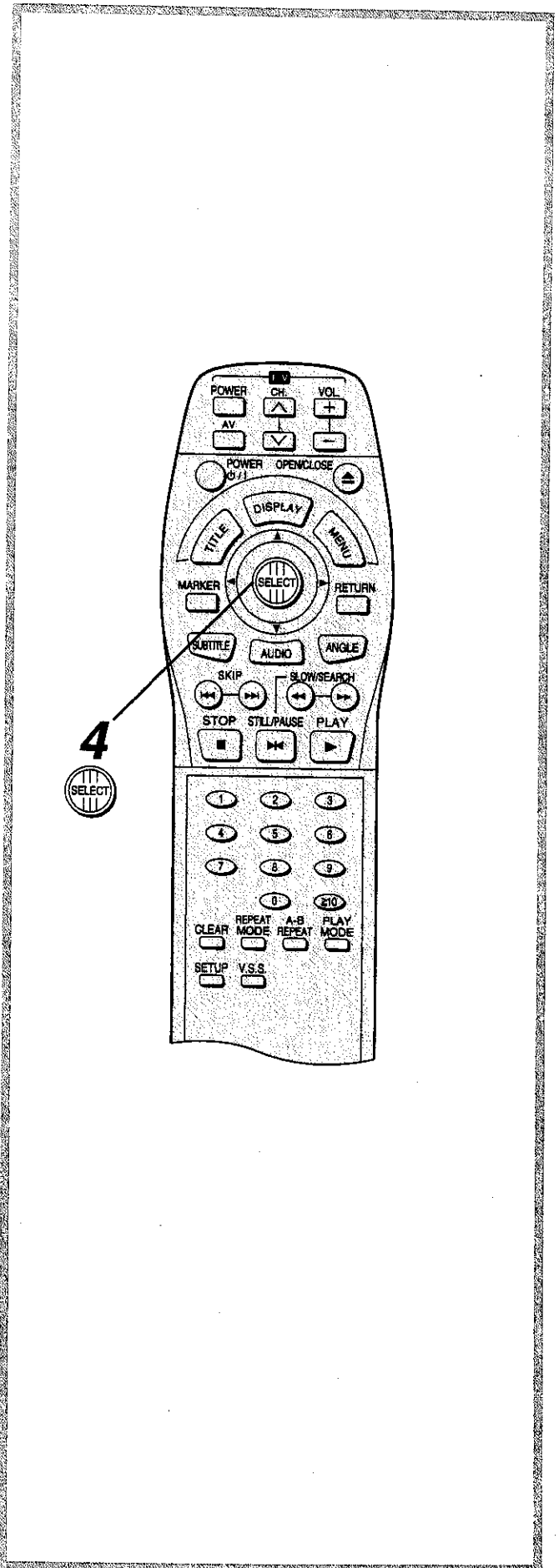

Initial settings

Other settings

- 1 At the initial settings screen
Select "9 Other Settings" by the joystick and press SELECT.

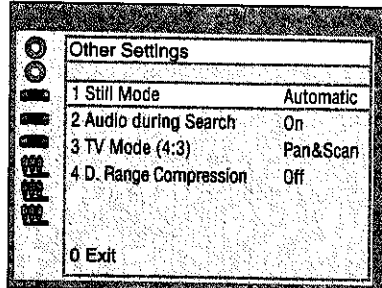

- 2 Select the preferred item (1-4) by the joystick and press SELECT.

When "1 Still Mode" is selected

Automatic : "Frame still" and "Field still" are automatically selected during the still mode.
(Factory setting)

Field : Select this setting when jittering occurs in the pictures even when "Automatic" is selected.

When "2 Audio during Search" is selected

On: Factory setting (When noises during search are disagreeable, select "Off".)

Off: Select this setting if audio during search is not necessary.

When "3 TV Mode (4:3)" is selected

Pan & Scan: The video material for a wide-screen will be played back in the Pan & Scan style on a conventional size TV.
(Factory setting)

- Video material not formatted in the Pan & Scan style will be played back in the letterbox style. (See page 37.)

Letterbox: Select this setting to play back the video material for a wide-screen in the letterbox style on a conventional size TV.

When "4 D. (Dynamic) Range Compression" is selected

Off: Normal audio range is selected. (Factory setting)

On: Select this setting to enjoy listening to dynamic sound even on a low volume. This is useful for late-night listening. [This function only works with Dolby Digital (AC-3) DVDs.]

- 3 Select the preferred value by the joystick at each screen and press SELECT.

The screen at the step 1 is displayed. Select "0" by the joystick and press SELECT to return to the initial settings screen.

Also refer to "Common procedures of initial settings" on page 32.

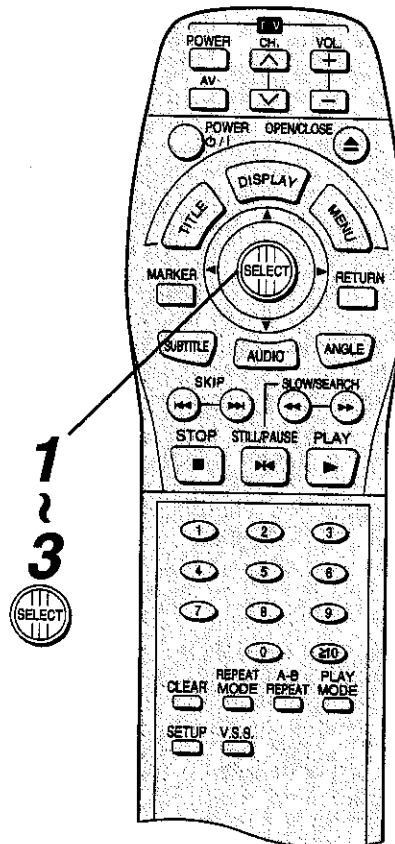

Operating the TV set by the remote control unit

Preparations

Press the numeric buttons while pressing the **POWER** button for the DVD/VIDEO CD/CD player to enter the manufacturer's code of your TV set.

●Be sure to enter the manufacturer's code in 2-digit.

Code	Manufacturer	Code	Manufacturer
01	1 PANASONIC/ National	11	SHARP
02	2 PANASONIC/ National	12	PHILIPS, SAMSUNG
03	3 PANASONIC/ National	13	NEC
04	4 PANASONIC/ National	14	SANYO
05	SONY	15	GOLDSTAR
06	TOSHIBA	16	GOLDSTAR
07	JVC	17	SAMSUNG
08	HITACHI	18	SAMSUNG
09	MITSUBISHI	19	SANYO
10	MITSUBISHI		

Note:

- For TV sets with two manufacturer's codes (such as PANASONIC), try both codes to confirm which code is effective.
- When the batteries of the remote control unit are replaced, perform the above operation again.

Operation

Press **TV** **POWER** to turn the TV set ON or OFF.

Press **TV** **AV** to select the TV input source.

Press **TV** **CH.** **^/v** to select the channel.

- ^: To increase the channel no.
- v: To decrease the channel no.

Press **TV** **VOL.** **+/-** to turn the volume up or down.

- +: To increase the volume
- : To decrease the volume

Note:

- Not all TV models and brands can be operated with the universal remote control supplied.

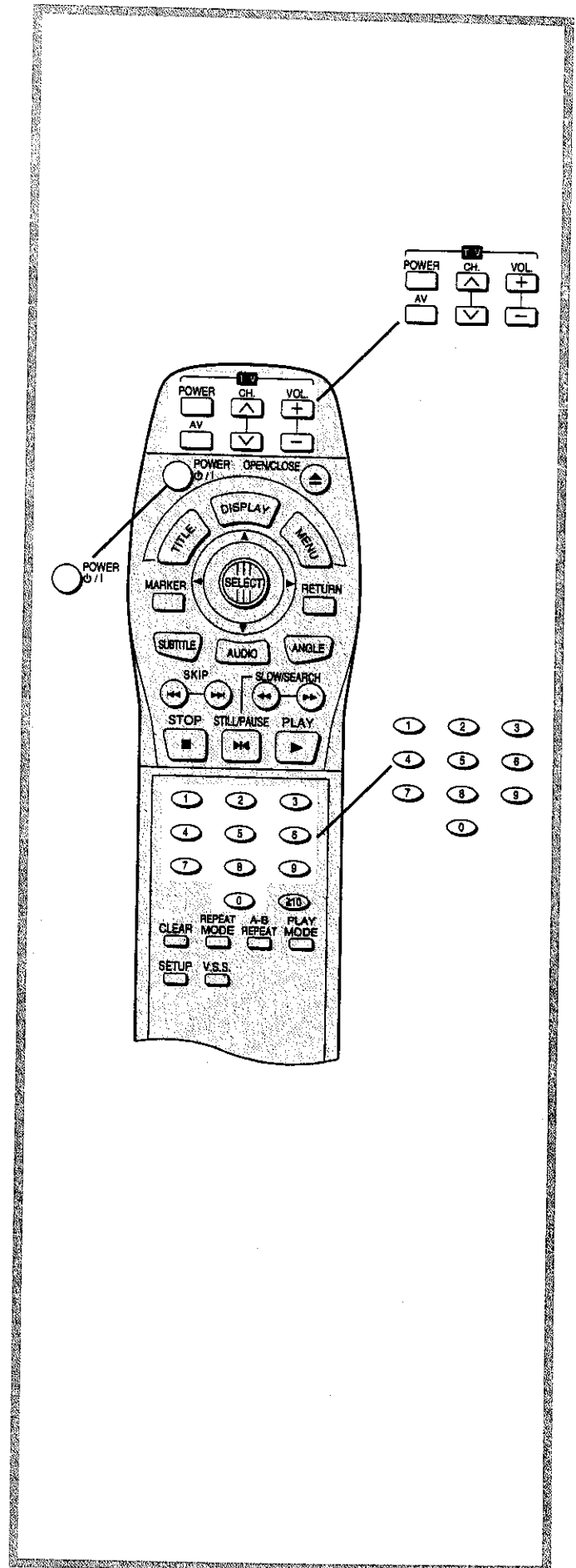

Disc handling and maintenance

Handling precautions

- Hold the disc by the edges so the surface will not be soiled with fingerprints. **(A)**
Fingerprints, dirt and scratches can cause skipping and distortion.
- Do not write on the label side with a ball-point pen or other writing utensils.
- Do not use record cleaning sprays, benzine, thinner, static electricity prevention liquids or any other solvent.
- Be careful not to drop or bend the disc.
- Do not install more than 1 disc on the disc tray.
- Do not try to close the disc tray when the disc is not installed properly. **(B)**
- Be sure to store the disc in its exclusive case when not in use.

If the surface is soiled **(C)**

Wipe gently with a soft, damp (water only) cloth.

When wiping discs, always move the cloth from the center hole toward the outer edge.

(If you wipe the discs using a circular motion, circular scratches are likely to occur, which will cause noise.)

If the disc is brought from a cold to a warm environment, moisture may form on the disc

Wipe this moisture off with a soft, dry, lint-free cloth before using the disc.

Improper disc storage

You can damage discs if you store them in the following places:

- Areas exposed to direct sunlight
- Humid or dusty areas
- Areas directly exposed to a heat outlet or heating appliance

Discs which cannot be played with this player

- DVD with Region No. other than "4" or "ALL"
- DVD-ROM
- DVD-R/DVD-RAM
- CD-ROM
- CDV
- CD-G
- Do not try to play Photo CD or CD-R.

Maintenance

- Be sure to switch the power to the standby mode and disconnect the AC mains lead before maintaining the unit.
- Wipe this unit with a dry soft cloth.
If the surfaces are extremely dirty, wipe clean with a cloth which has been dipped in a weak soap-and-water solution and wrung out thoroughly, and then wipe again with a dry cloth.
- Never use alcohol, benzine, thinner, cleaning fluid or other chemicals. And do not use compressed air to remove dust.

A

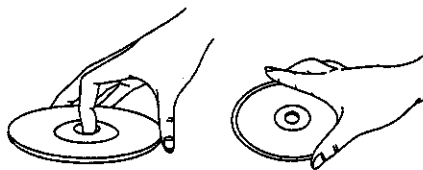

B

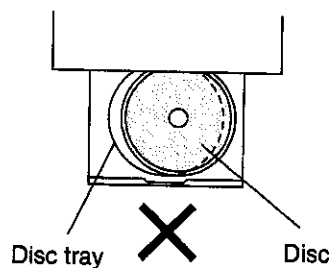

C



Troubleshooting

Before requesting service for this unit, check the chart below for a possible cause of the problem you are experiencing. Some simple checks or a minor adjustment on your part may eliminate the problem and restore proper operation. If you are in doubt about some of the check points, or if the remedies indicated in the chart do not solve the problem, consult your dealer for instructions.

Symptom (Common)	Remedy
No power.	Insert the AC mains lead securely into the power outlet.
Power is automatically switched to the standby mode.	The power is automatically switched to the standby mode after approx. 30 minutes have elapsed in the stop mode (auto power-off function). Turn the power back on.
<ul style="list-style-type: none"> • Play fails to start even when PLAY is pressed. • Play commences but then stops immediately. 	<ul style="list-style-type: none"> • Condensation has formed: wait about 1 to 2 hours to allow the player to dry out. • This player cannot play discs other than DVDs, Video CDs and CDs. • The disc may be dirty and may require cleaning. • Ensure that the disc is installed with the label side up.
No picture.	<ul style="list-style-type: none"> • Ensure that the equipment is connected properly. • Ensure that the input setting for the TV is a "Video" position.
<ul style="list-style-type: none"> • No sound. • Distorted sound. 	<ul style="list-style-type: none"> • Ensure that the equipment is connected properly. • Ensure that the input settings for the TV and stereo system are proper. • Adjust the master volume using the GUI screen for player information.
Picture is distorted during rapid advance or rapid reverse.	The picture will be somewhat distorted at times: this is normal.
No rapid advance (or rapid reverse) play.	Some discs may have sections which prohibit rapid advance (or rapid reverse).
No 4:3 (16:9) picture.	Choose the correct setup "TV Aspect" item which matches the TV set used.
No on-screen display.	The OFF setting is selected for "On-Screen Messages": select ON.
No surround sound.	Choose the correct setup at the "Speaker setting" which matches your stereo system.
No operations can be performed with the remote control.	<ul style="list-style-type: none"> • Check the batteries are installed with the correct polarities (+ and -). • The batteries are depleted: replace them with new ones. • Point the remote control unit at the remote control sensor and operate. • Operate the remote control unit at a distance of not more than 7 meters from the remote control sensor. • Remove the obstacles between the remote control unit and remote control sensor.
No key operation (by the unit and/or the remote control) is effective.	Switch the power to the standby mode and then return to ON. Alternatively, switch the power to the standby mode, disconnect the AC mains lead and then re-connect it. (The player may not be operating properly due to lightning, static electricity or some other external factor.)
TV set cannot be operated by the remote control.	Not all TV models and brands can be operated with the universal remote control supplied.
GUI Screen not displayed or only partially displayed on the TV Screen.	Select the appropriate TV screen type by consulting the operation manual of the TV.

Symptom [DVD]	Remedy
Play does not commence even when title is selected.	Confirm the "Ratings" setting.

Symptom [DVD]	Remedy
Audio soundtrack and/or subtitle language is not the one selected at the initial settings.	If the audio soundtrack and/or subtitle language does not exist on the disc, the language selected at the initial settings will not be seen/heard.
The menu is displayed in French (example).	The setup "Menus" of "Disc Languages" is set to French: select English.
No subtitles.	<ul style="list-style-type: none"> • Subtitles appear only with discs which contain them. • Subtitles are cleared from the TV monitor. Perform the steps on page 28 to display the subtitles.
Alternative audio soundtrack (or subtitle) languages fail to be selected.	<ul style="list-style-type: none"> • An alternative language is not selected with discs which do not contain more than one language. • In the case of some discs, the alternative language cannot be selected by operating the AUDIO or SUBTITLE button. Try selecting it from the DVD menu if one is available.
Angle cannot be changed.	This function is dependent on software availability. Even if a disc has a number of angles recorded, these angles may be recorded for specific scenes only (when the ANGLE indicator on the unit lights up.)
The password for age restriction has been forgotten.	While the unit is in the stop mode, hold the unit's ◀◀ SKIP button and the STILL/PAUSE button down simultaneously and then hold the POWER button down for longer than 3 seconds (until "Initialized" disappears from the TV monitor). The lock will be released and all initial settings will return to the default values.

Symptom [Video CD]	Remedy
No menu play.	This function works only for Video CDs with playback control.

Self-diagnosis display function

When an error or trouble is detected during operation, a service number appears in the display window. When a service number has appeared, check out the details given below.

Service number	Player status	Remedy
U11	Disc is dirty.	Wipe the disc clean.
H □ □	Trouble is likely to have occurred. The number following "H" differs depending on the status of the player.	Switch the power to the standby mode and then return to ON. Alternatively, switch the power to the standby mode, disconnect the AC mains lead and then re-connect it. If the service number fails to be cleared even when the remedial action is taken, ask for the service engineer to repair the player.

Definition of terms

Angle

Recorded onto some DVD discs are scenes which have been simultaneously shot from a number of different angles (the same scene is shot from the front, from the left side, from the right side, etc.). With such discs, the ANGLE button can be used to view the scene from different angles.

Chapter number

These numbers are recorded on DVD discs. A title is subdivided into many sections, each of which is numbered, and specific parts of video presentations can be searched quickly using these numbers.

DVD

This refers to a high-density optical disc on which high-quality pictures and sound have been recorded by means of digital signals. Incorporating a new video compression technology (MPEG II) and high-density recording technology, DVD enables esthetically pleasing full-motion video to be recorded over long periods of time (for instance, a whole movie can be recorded).

DVD has a structure consisting of two 0.6 mm thin discs which are adhered to each other. Since the thinner the disc, the higher the density at which the information can be recorded, a DVD disc has a greater capacity than a single 1.2 mm thick disc. Since the two thin discs are adhered to each other, there is the potential to achieve double-sided play sometime in the future for even longer duration play.

Playback control

This is recorded on a Video CD (version 2.0). The scenes or information to be viewed (or listened to) can be selected interactively with the TV monitor by looking at the menu shown on the TV monitor.

Subtitles

These are the printed lines appearing at the bottom of the screen which translate or transcribe the dialogue. They are recorded on DVD discs.

Time number

This indicates the play time which has elapsed from the start of a disc or a title. It can be used to find a specific scene quickly. (It may not work with some discs.)

Title number

These numbers are recorded on DVD discs. When a disc contains two or more movies, these movies are numbered as title 1, title 2, etc.

Track number

These numbers are assigned to the tracks which are recorded on Video CDs and CDs. They enable specific tracks to be located quickly.

Video CD

This contains recordings of pictures and sound whose quality is on a par with that of videotape. This player also supports Video CDs with playback control (version 2.0).

Specifications

Power requirements:	AC 220–240 V, 50 Hz
Power consumption:	22 W (approx. 4 W when set to standby mode by the power button or the remote control)

Signal system:	PAL 625/50, PAL 525/60
Weight:	3.6 kg
Dimensions:	430 (W)×290 (D)×87.5 (H) mm (excluding protrusions)

Operating temperature range:
+5 to +35 °C

Operating humidity range:
5 to 90% (no condensation)

Discs played:

(1) DVD-VIDEO disc

- 12 cm single-sided, single-layer
- 12 cm single-sided, double-layer
- 12 cm double-sided, double-layer (one layer per side)
- 8 cm single-sided, single-layer
- 8 cm single-sided, double-layer
- 8 cm double-sided, double-layer (one layer per side)

(2) Compact disc (CD-DA, VIDEO CD)

- 12 cm disc
- 8 cm disc

S-video output (separate YC signal output):

- Y output level: 1 Vp-p (75Ω)
- C output level: 0.300 Vp-p (75Ω)
- Output connector: S terminal (1 system)

Video output:

- Output level: 1 Vp-p (75Ω)
- Output connector: Pin jack (2 systems)

Audio output:

- Output level: 2 Vrms (1 kHz, 0 dB)
- Output connector: Pin jack
- 5.1ch mixed output: 1 system (2ch)
- 5.1ch discrete output: 1 system (5.1ch)

Audio signal output characteristics:

- Frequency response:
 - DVD (linear audio):
 - 2 Hz–22 kHz (48 kHz sampling)
 - 2 Hz–44 kHz (96 kHz sampling)
 - CD audio: 2 Hz–20 kHz (EIAJ)
- S/N ratio:
 - CD audio: 115 dB (EIAJ)
- Dynamic range:
 - DVD (linear audio): 102 dB
 - CD audio: 99 dB (EIAJ)
- Total harmonic distortion:
 - CD audio: 0.0025% (EIAJ)

Digital audio output:

- Optical digital output: Optical connector
- Coaxial digital output: Pin jack

PHONES jack: Stereo, M6 jack

Pickup: Wave length: 655 nm
Laser power: CLASS 2

Specifications are subject to change without notice.
Weight and dimensions are approximate.

Language code list

Enter the appropriate code number for the initial settings "Audio", "Subtitle" and/or "Menus" (see page 33).

Code	Language Name	Code	Language Name	Code	Language Name	Code	Language Name
6565	Afar	7079	Faroese	7678	Lingala	8375	Slovak
6566	Abkhazian	7082	French	7679	Laothian	8376	Slovenian
6570	Afrikaans	7089	Frisian	7684	Lithuanian	8377	Samoan
6577	Ameharic	7165	Irish	7686	Latvian, Lettish	8378	Shona
6582	Arabic	7168	Scots Gaelic	7771	Malagasy	8379	Somali
6583	Assamese	7176	Galician	7773	Maori	8381	Albanian
6588	Aymara	7178	Guarani	7775	Macedonian	8382	Serbian
6590	Azerbaijani	7185	Gujarati	7776	Malayalam	8385	Sundanese
6665	Bashkir	7265	Hausa	7778	Mongolian	8386	Swedish
6669	Byelorussian	7273	Hindi	7779	Moldavian	8387	Swahili
6671	Bulgarian	7282	Croatian	7782	Marathi	8465	Tamil
6672	Bihari	7285	Hungarian	7783	Malay	8469	Telugu
6678	Bengali; Bangla	7289	Armenian	7784	Maltese	8471	Tajik
6679	Tibetan	7365	Interlingua	7789	Burmese	8472	Thai
6682	Breton	7378	Indonesian	7865	Nauru	8473	Tigrinya
6765	Catalan	7383	Icelandic	7869	Nepali	8475	Turkmen
6779	Corsican	7384	Italian	7876	Dutch	8476	Tagalog
6783	Czech	7387	Hebrew	7879	Norwegian	8479	Tonga
6789	Welsh	7465	Japanese	7982	Oriya	8482	Turkish
6865	Danish	7473	Yiddish	8065	Panjabi	8484	Tatar
6869	German	7487	Javanese	8076	Polish	8487	Twi
6890	Bhutani	7565	Georgian	8083	Pashto, Pushto	8575	Ukrainian
6976	Greek	7575	Kazakh	8084	Portuguese	8582	Urdu
6978	English	7576	Greenlandic	8185	Quechua	8590	Uzbek
6979	Esperanto	7577	Cambodian	8277	Rhaeto-Romance	8673	Vietnamese
6983	Spanish	7578	Kannada	8279	Romanian	8679	Volapük
6984	Estonian	7579	Korean	8285	Russian	8779	Wolof
6985	Basque	7583	Kashmiri	8365	Sanskrit	8872	Xhosa
7065	Persian	7585	Kurdish	8368	Sindhi	8979	Yoruba
7073	Finnish	7589	Kirghiz	8372	Serbo-Croatian	9072	Chinese
7074	Fiji	7665	Latin	8373	Singhalese	9085	Zulu